



BEAUTIFUL ON THE OUTSIDE. SMART ON THE INSIDE.®





BEAUTIFUL ON THE OUTSIDE. SMART ON THE INSIDE.®



CLASSICALLY BEAUTIFUL

With timeless appeal and an endless array of options, Schrock™ Cabinetry is just the right offering of styles, colors and finishing touches to transform your space into a unique expression of your personality.



SURPRISINGLY SMART

Equipped inside with maximum function and versatility, our cabinets are thoughtfully designed to improve home organization and make busy lives easier.



PROVEN SERVICE

Our legacy has been proven time and again with outstanding quality, dependable delivery and superior service. Trust the Schrock name for expertly crafted cabinetry that stands the test of time.



TABLE OF CONTENTS

WHAT'S NEW	04
KITCHENS, BATHS AND OTHER ROOMS	06
HARDWARE	40
GLASS	42
MOULDINGS & EMBELLISHMENTS	46
SMARTSOLUTIONS™	48
DOOR STYLES & FINISH OPTIONS	52
CONSTRUCTION	62
CABINET SPECIFICATIONS	66

more styles



CARMIN 5-PIECE DRAWER FRONT



SWOOPED BASEBOARD
Applied under counter



GOURMET SUPERCABINET™

more organization



TOEKICK DRAWER MODIFICATION

more modifications



INSTALLED WOOD
TRAY DIVIDERS



EXPANDED GLASS AVAILABILITY

WHAT'S NEW FOR 2012

Schrock Cabinetry embraces the most current trends and innovations in cabinetry. New to this year's collection is an array of new finishes, features and organizational solutions to personalize your room. We hope our 2012 additions increase function to your spaces and inspire creativity within your home.



4 PRAIRIE MULLION DOORS



FLUSH TOEKICK WITH ARCH VALANCE MODIFICATION

more customization



BLACK FOREST



GREY STONE GLAZE



more finishes



SAND DUNE

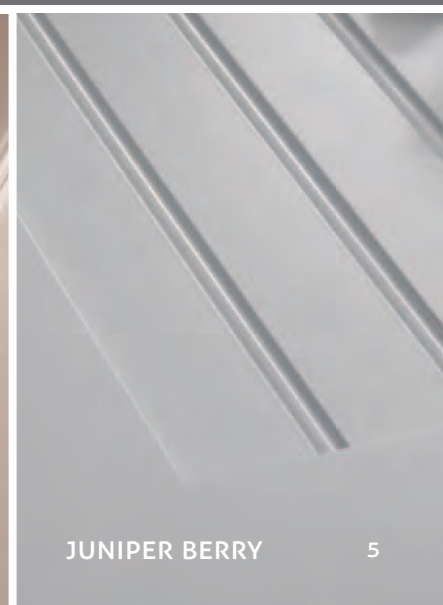

JUNIPER BERRY



OAK SAHARA & MAPLE MOSS FEATURING RAISED DRAWER FRONT



CRAFTSMAN FOOT

LARGE SHAKER CORBEL

BRINKMAN

AGELESS STYLE

The relaxed detailing of Brinkman imparts an ageless style and charm to this ideal, casual treasure. Cabinetry features partial overlay doors with raised center panels and solid profiled drawer fronts. Optional raised drawer front is available for added dimension. Choose between arch and square wall cabinet doors with square base cabinet doors.

Brinkman is available in Maple, Cherry and Oak. Brinkman cabinets feature solid wood center panels and frames.





MAPLE DOVER

MORGAN

CASUAL CANDOR

The uncomplicated simplicity of Morgan breathes casual candor to this fresh and inviting carefree favorite. Cabinetry features full overlay doors with flat center panels and solid profiled drawer fronts for a clean, uniform feel.

Morgan is available in Maple, Cherry, Alder and Rustic Alder. Morgan cabinets feature veneer center panels and solid wood frames.

SCROLL ISLAND LEG

OPEN WALL CABINET

SEEDED TEXTURED GLASS





CHERRY LIGHT

Kitchen design by Sherrie Linn: Linn's Prestige Kitchens in Destin, Florida



VALLEY FORGE UNDERCABINET MOULDING

PRESTLEY

CRISP CONTEMPORARY

Clean and modern, Prestley exudes a crisp, current approach for cutting-edge contemporary environments. Cabinetry features full overlay slab style door and drawer fronts for a fluent, clean-line design.

Prestley is available in Maple and Cherry. Prestley cabinets feature veneer face and back with solid wood edging.





MAPLE COCONUT WITH GREY STONE GLAZE

GALENA

POETIC SPLENDOR

The harmonious character of Galena awakens rhythmic charm and poetic splendor for a casual and inviting atmosphere. Cabinetry features full overlay doors with raised center panels and solid profiled drawer fronts.

Galena is available in Maple, Cherry and Alder. Galena cabinets feature solid wood center panels and frames.

MULLION DOORS

SUPERCABINET™ V.2

TILT-OUT ON 5-PIECE DRAWER FRONT





MAPLE PALOMINO AND OASIS



AINSLEY

SPIRITED CHARISMA

The inviting personality of Ainsley fuses with old world charm and spirited charisma for a casual tone and lasting impression. Cabinetry features full overlay doors with raised center panels and solid slab style drawer fronts. Optional five-piece drawer front construction is available for added detail and dimension.

Ainsley is available in Maple. Ainsley cabinets feature solid wood center panels and frames.

ART CORBEL

LILLE FOOT

STRAIGHT TAMBOUR

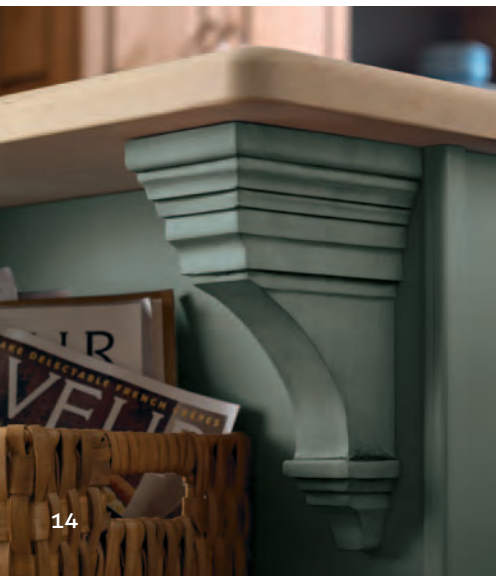



CHERRY CATTAIL

PRESTLEY

RELAXED AMBIANCE

Clean and modern, Prestley reflects a fresh collaboration of informal simplicity and relaxed ambiance. Cabinetry features full overlay slab style door and drawer fronts for a fluent, clean-line design.

Prestley is available in Maple and Cherry. Prestley cabinets feature veneer face and back with solid wood edging.

SQUARE FOOT

BASE RECYCLING CENTER

WINE STORAGE





MAPLE OASIS



Kitchen design by Sherrie Linn, Linn's Prestige Kitchens in Destin, Florida

CUT FOR GLASS DOORS WITH GLASS SHELVES



PRINCETON

COMPOSED CANVAS

Princeton provides a composed canvas of tailored artistry for casual entertaining that leaves a lasting impression. Cabinetry features partial overlay doors with raised center panels and solid profiled drawer fronts. Choose between arch and square wall cabinet doors with square base cabinet doors.

Princeton is available in Maple and Cherry. Princeton cabinets feature veneer center panels and solid wood frames.





MAPLE BRIERWOOD AND HONEYSUCKLE

MORGAN

FRESH SIMPLICITY

The uncomplicated simplicity of Morgan breathes casual candor to this fresh and inviting carefree favorite in any space. Cabinetry features full overlay doors with flat center panels and solid profiled drawer fronts for a clean, uniform feel.

Morgan is available in Maple, Cherry, Alder and Rustic Alder. Morgan cabinets feature veneer center panels and solid wood frames.

2-SIDED ISLAND LEG

OLDE WORLD CORBEL

METRO ISLAND COLUMN

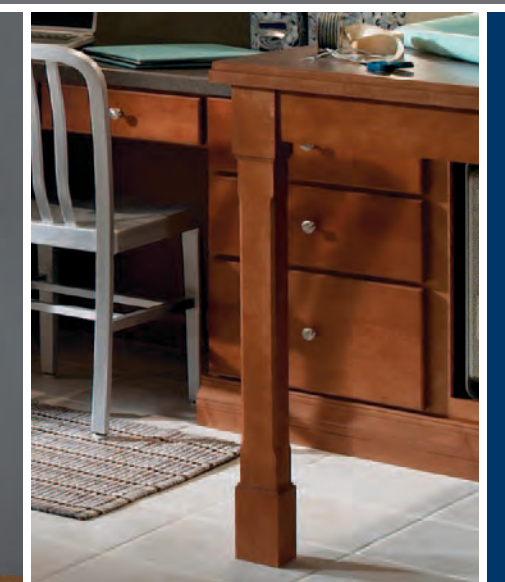



CHERRY CIDER



ISLAND LEGS

SLIDING SHELVES WITH LID ORGANIZER

ASBURY

MASTERFUL BLEND

The rich detailing of Asbury imparts a masterful blend of texture and warmth to evoke a versatile, timeless appeal. Cabinetry features full overlay doors with raised center panels and five-piece mitered drawer front construction for a classic, framed style.

Asbury is available in Maple and Cherry. Asbury cabinets feature solid wood center panels and frames.





RUSTIC ALDER COFFEE: BRINKMAN MAPLE HEIRLOOM BLACK

HARPER

MISSION LEG

UTILITY ORGANIZER

FLOATING HEARTH

RUSTIC TRANQUILITY

The composition of Harper offers casual simplicity and rustic tranquility to create a relaxed and welcoming impression. Cabinetry features partial overlay doors with raised center panels and solid profiled drawer fronts for a clean, consistent look.

Harper is available in Alder and Rustic Alder. Harper cabinets feature solid wood center panels and frames.





MAPLE SANGRIA: CORTLAND MAPLE COCONUT WITH TOASTED ALMOND GLAZE



BRANTLEY

ARTISTIC HARMONY

Based on the timeless foundation of the Arts and Crafts movement, Brantley translates artistic lines and captivating detailing into composed harmony. Cabinetry features full overlay doors with reversed raised center panels and five-piece mitered drawer front construction for a classic, framed style.

Brantley is available in Maple and Cherry. Cortland is available in Maple. Brantley and Cortland cabinets feature solid wood center panels and frames.

WARMING DRAWER CABINET

FAUX STRAP HINGES

MISSION CORBEL





MAPLE STORM AND TIDAL MIST

HUXLEY

STREAMLINED STRUCTURE

Streamlined for contemporary appeal, Huxley offers simple forms and crisp structure for a seamless expression of modern spirit. Cabinetry features full overlay doors with reverse raised center panels and solid slab style drawer fronts. Optional five-piece drawer front construction is available for added detail and dimension.

Huxley is available in Maple, Cherry, Alder, Rustic Alder, and Oak. Huxley cabinets feature solid wood center panels and frames.

BASE SPICE DRAWER — SLAB DRAWER OPTION

MISSION INSERT





RUSTIC ALDER WHISKEY BLACK



CHANLEY

SPOOL LEG AND BASE OPEN BASKET

SCROLL CORBELS AND WALL SPICE DRAWERS

QUAINT AMBIANCE

The traditional charm of Chanley offers a look at the quaint detailing of days past and provides instant ambiance with layers of interest. Cabinetry features full overlay doors with raised center panels and solid profiled drawer fronts. Optional five-piece drawer front construction is available for added detail and dimension.

Chanley is available in Alder and Rustic Alder. Chanley cabinets feature solid wood center panels and frames.





PURESTYLE™ LAMINATE WHITE
PRESTLEY CHERRY LIGHT: MAPLE BLACK

MORAVIA

PICTURE PERFECT

A creative blend of refined elegance, Moravia inspires picture perfect embellishments that provide a canvas for imagination. Cabinetry features full overlay doors with flat center panels and solid slab style drawer fronts. Optional five-piece drawer front construction is available for added detail and dimension.

Moravia is available in PureStyle™ Laminate. Moravia cabinets feature durable laminate material on doors and drawers.

SILHOUETTE TEXTURED GLASS

BAROQUE INSERT MOULDING

BAROQUE VALANCE





CHERRY CHOCOLATE: MAPLE HEIRLOOM TIDAL MIST



PRINCETON

LYNDHURST ART GLASS

TOEKICK TULIP FOOT

WORTHY INDULGENCE

The upscale elegance of Princeton exudes European-inspired character for a generous fusion of worthy indulgence. Cabinetry features partial overlay doors with raised center panels and solid profiled drawer fronts. Choose between arch and square wall cabinet doors with square base cabinet doors.

Princeton is available in Maple and Cherry. Princeton cabinets feature veneer center panels and solid wood frames.





CHERRY BLACK FOREST

CARMIN

BASE CORNER WITH CURVED PULLOUT

DIAGONAL WALL STACKING CABINET

OPEN SHELVING

HANDSOME BALANCE

The classic style of Carmin adds a balance of detail and dimension to this enduring, steadfast style. Cabinetry features full overlay doors with raised center panels and solid routed drawer fronts. Optional five-piece drawer front construction is available for added depth.

Carmin is available in Maple and Cherry. Carmin cabinets feature veneer center panels and solid wood frames.





MAPLE COCONUT & STORM



PARKER

BIJOU MOULDING INSERT

BUILT-IN SHELVING

ELLINGTON ART GLASS

LAYERED CHARM

The traditional charm of Parker alludes to the faithful details of days past and provides instant ambiance and layers of interest. Cabinetry features full overlay doors with raised center panels and solid raised profile drawer fronts. Optional five-piece drawer front construction is available for added detail and dimension. Choose between arch and square wall cabinet doors with square base cabinet doors.

Parker is available in Maple and Cherry. Parker cabinets feature solid wood center panels and frames.



DECORATIVE HARDWARE

TRUE NEW OLD TRADITIONAL



- A. KNOBH06
Copper Antique Highlight
- B. KNOBH20
Red Rust Antique
- C. KNOBH10
Nickel Antique Highlight
- D. KNOBH07
Copper Antique Highlight
- E. KNOBH37
Red Rust Antique
- F. KNOBH35
Rust Pewter
- G. PULLH08
Copper Antique Highlight
- H. PULLH36
Red Rust Antique
- I. PULLH11
Nickel Antique Highlight
- J. PULLH38
Vibra Black Nickel
- K. PULLH39
Vibra Black Nickel
- L. PULLH34
Antique Brass
- M. HINGEFH2
Pewter

CLASSIC HERITAGE FASCINATION



- N. KNOBH40
Black
- O. KNOBH46
Vibra Black Nickel
- P. KNOBH43
Windsor Antique
- Q. HINGEFH3
Black
- R. PULLH42
Black
- S. PULLH44
Vibra Black Nickel
- T. PULLH47
Vibra Black Nickel
- U. PULLH41
Black
- V. PULLH45
Vibra Black Nickel

BOUTIQUE CONTINENTAL

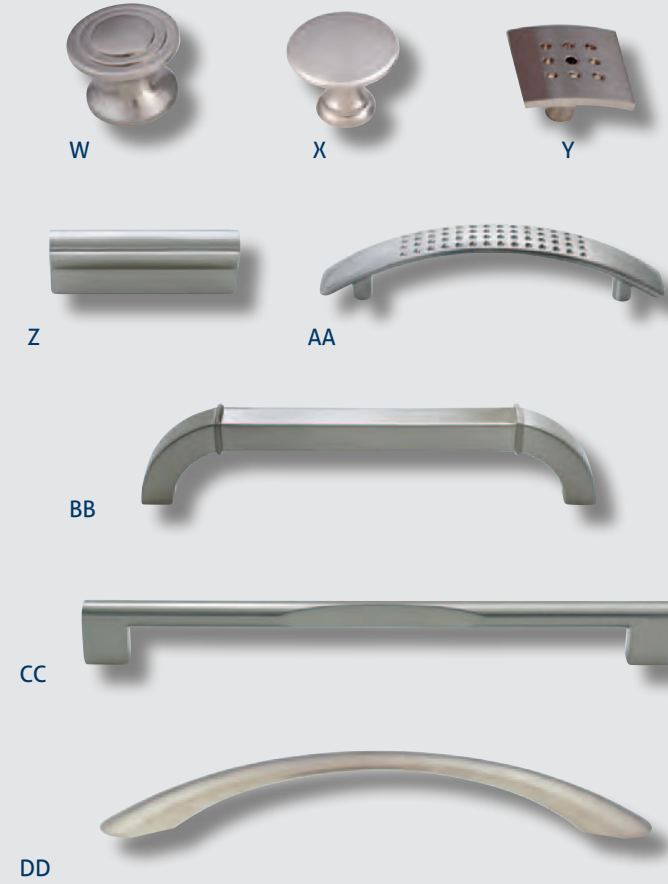

- W. KNOBH23
Ultra Brush Nickel
- X. KNOBH31
Ultra Brush Nickel
- Y. KNOBH32
Ultra Brush Nickel
- Z. PULLH51
Stainless Steel
- AA. PULLH53
Satin Nickel
- BB. PULLH50
Satin Nickel
- CC. PULLH52
Stainless Steel
- DD. PULLH30
Ultra Brush Nickel

TRUE COMPLEMENT



- EE. KNOBH54
Black Nickel with Brown Glaze
- FF. KNOBH57
South Haven Antique
- GG. KNOBH58
Oil Rubbed Bronze
- HH. KNOBH62
Black
- II. KNOBH65
Stainless Steel
- JJ. PULLH60
Oil Rubbed Bronze
- KK. PULLH56
South Haven Antique
- LL. PULLH55
Black Nickel with Brown Glaze
- MM. PULLH63
Satin Nickel
- NN. PULLH64
Satin Nickel
- OO. PULLH59
Oil Rubbed Bronze
- PP. PULLH61
Black
- QQ. PULLH66
Black Nickel

GLASS SPECIALTY DOORS

TEXTURED GLASS

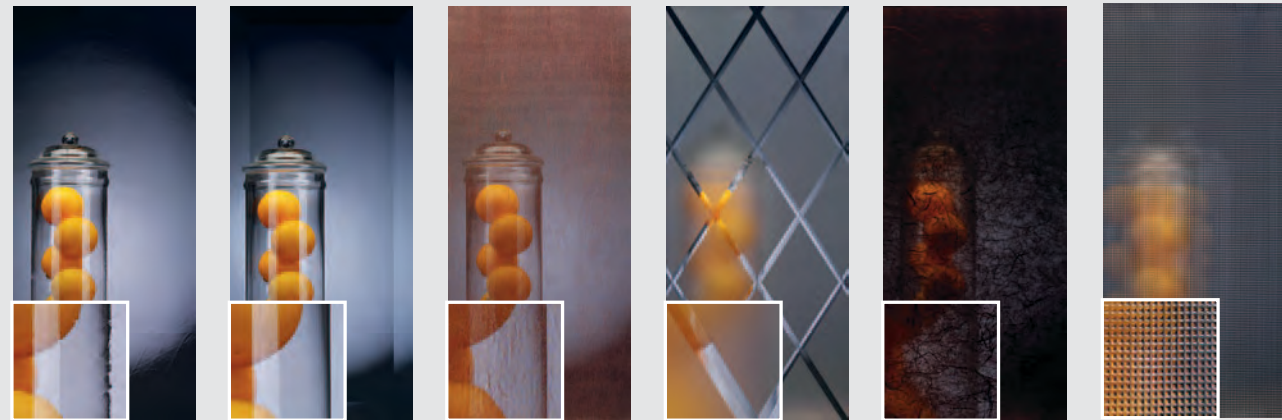

ANTIQUE BEVELED BRONZE FABRIC CENTURIAN COCOA RICE CROSS REEDED

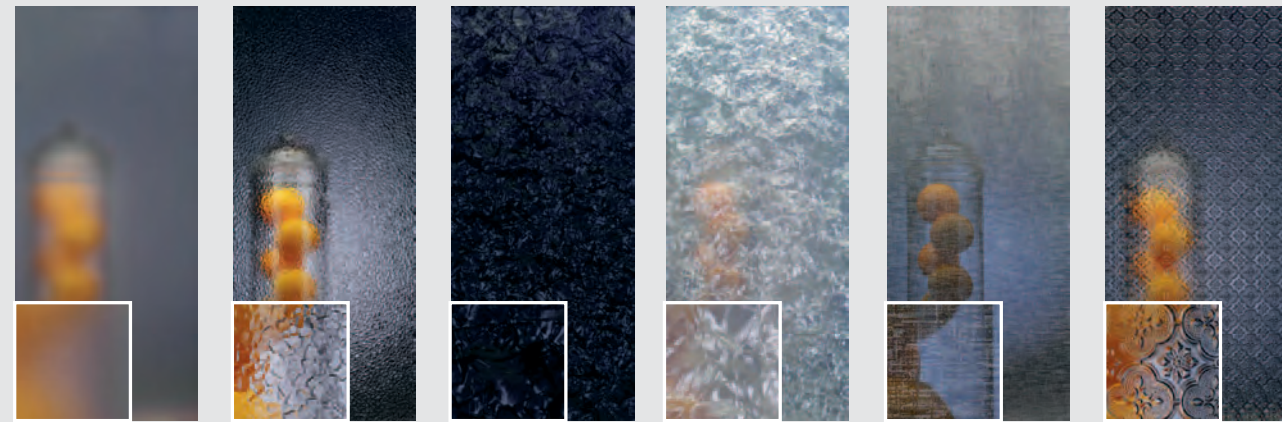

FROST HAMMERED MARBLEIZED CHARCOAL MARBLEIZED PEARL METALLIC LINEN MORISCO

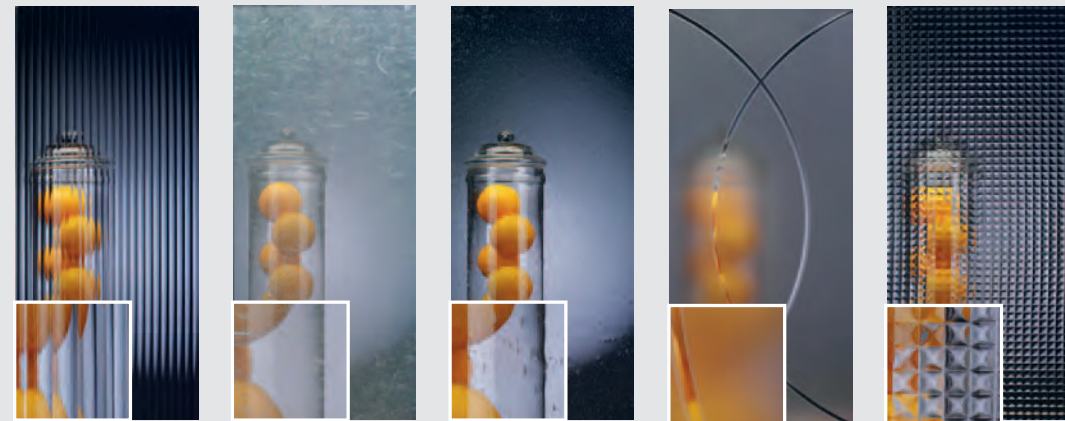

REEDED RICE PAPER SEEDED SILHOUETTE STRELLI

ART GLASS



ANSON AVONDALE CAMBRIDGE CHALET CHARLOTTE EDMONT

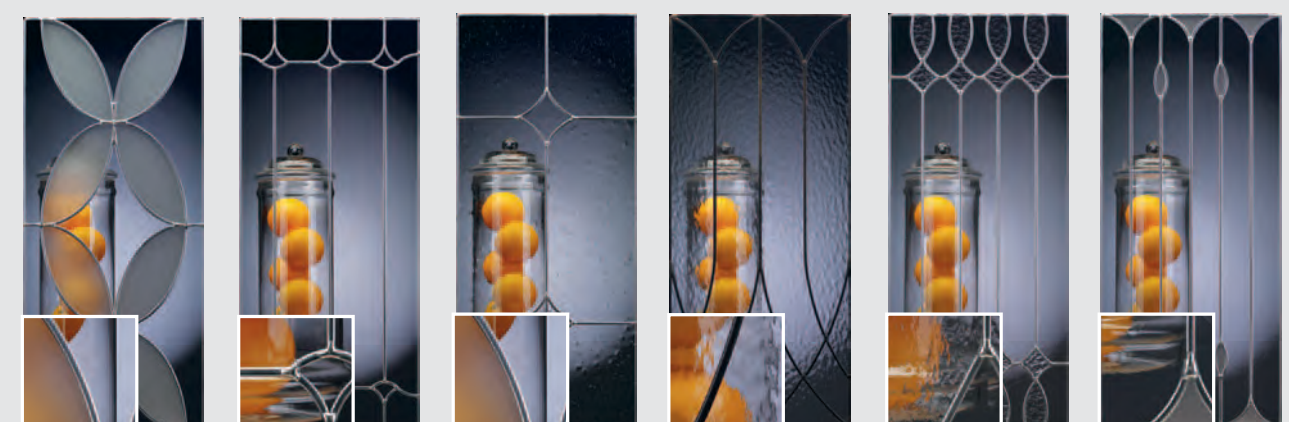

ELLINGTON LANAI LONSDALE LYNDHURST MAISON MANOR



MERIDEN PAVILLION PLANTATION PORTICO QUINCY USONIAN

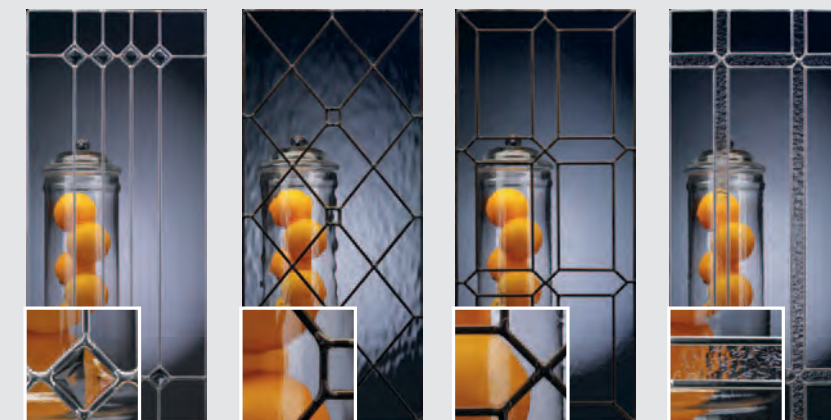

VILLA WATERBURY WESCOTT WICKFORD

CLEAR GLASS IS AVAILABLE

GLASS SPECIALTY DOORS



A.



B.



C.



D.



E.



F.



G.

A. ELLINGTON ART GLASS

B. VILLA ART GLASS

C. MANOR ART GLASS

D. SILHOUETTE TEXTURED GLASS

E. SEEDED TEXTURED GLASS

F. PRAIRIE MULLION DOOR

G. SHAKER MULLION DOOR

H. MULLION SQUARE DOOR*

I. MULLION SQUARE DOOR*

* also available in arch and cathedral

DESIGN DETAILS THAT INVITE SOPHISTICATION

In pursuit for personalization, discover our new glass door possibilities and create the perfect cabinetry accent for your unique space. Our alluring mix of glass and mullion styles further expand the Schrock design palette and allow for decorative glass to be added to wall, base and tall cabinets, without exception, for inviting sophistication.



H.



I.

MOULDINGS & EMBELLISHMENTS

Schrock Cabinetry offers a full offering of mouldings, embellishments and architectural accents. Ask your Schrock dealer for more details.



J. BIJOU INSERT MOULDING

K. ROMAN WEAVE LEG

L. ACANTHUS INSERT MOULDING

M. BASEBOARD MOULDING

N. WIDE SCRIBE MOULDING

O. SMALL LIGHT RAIL

A. ACANTHUS ONLY

B. BAROQUE INSERT MOULDING

C. BAROQUE CORBEL

D. FRENCH COUNTRY LEG

E. CELTIC CORBEL

F. ART CORBEL

G. BAROQUE VALANCE

H. MISSION CORBEL

I. LILLE FOOT



M.

N.

O.



A. BASE EASY-ACCESS CABINET
 B. OVEN CABINET WITH WOOD TRAY DIVIDER
 C. TIERED CUTLERY DIVIDER
 D. BASE SUPERCABINET™ V.2

E. TALL PANTRY PULLOUT
 F. UTILITY STORAGE CABINET WITH POTS AND PANS PULLOUT RACK
 G. GOURMET SUPERCABINET™
 H. BASE RECYCLING CENTER

I. TRASH CAN PULLOUT WITH TOEKICK MODIFICATION
 J. BASE CORNER WITH PULLOUT
 K. ROLLOUT TRAY DIVIDER
 L. BASE PANTRY PULLOUT

CABINET INTERIORS WITH FLEXIBILITY, ACCESSIBILITY AND VERSATILITY.

Inside those beautiful doors and drawers is a world of thoughtful organization accessories designed to make your life easier. Our popular SuperCabinet™, for example, offers door storage, pullout trays and adjustable shelves in several configurations to suit your space and your style.

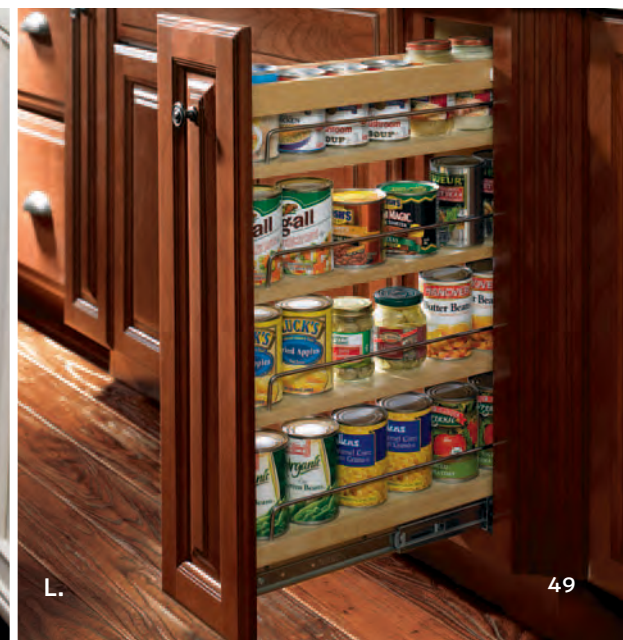

SMARTSOLUTIONS™ ORGANIZATION



A.



B.



E.



F.

A. BASE MIXER CABINET

B. BASE CORNER WITH CURVED PULLOUT

C. BASE POTS AND PANS PULLOUT

D. BASE WASTEBASKET WITH LID

E. DEEP BIN LAZY SUSAN

F. OVEN CABINET DEEP DRAWER

G. SINK BASE SUPERCABINET™ WITH CABMAT™

H. HEARTH PULLOUT

I. SEGMENTED SUPER LAZY SUSAN

J. SINK BASE WITH TILTDOWN

K. WALL EASY ACCESS STORAGE WITH CABMAT™



C.



D.



G.



H.



I.

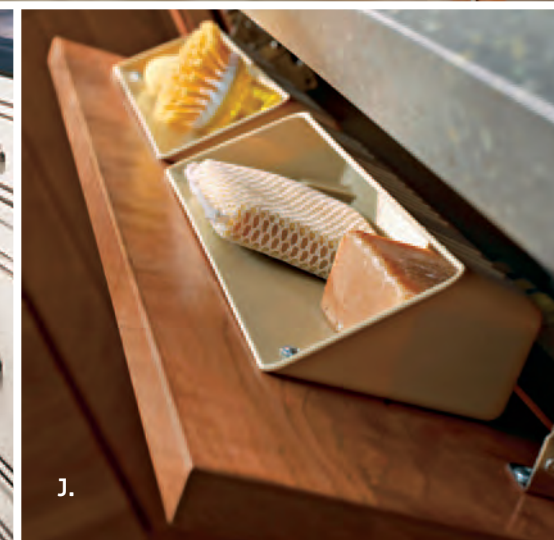

J.



K.



Maple is noted for delicate grain patterns that may include mineral streaks and tiny "bird's eye" dots. Maple's naturally light color ranges from soft ivory to pale reddish-tan, with a smooth and uniform surface that accepts any finish with beautiful results.



AINSLEY •
full overlay



AINSLEY •
full overlay
5-piece drawer option



ASBURY •
full overlay



BRANTLEY
full overlay



BRINKMAN •
partial overlay



BRINKMAN •
partial overlay
raised drawer option



BRINKMAN ARCH •
partial overlay

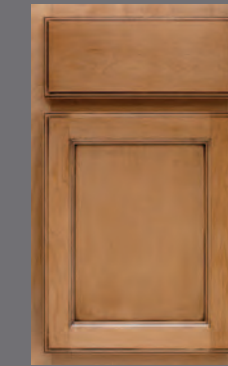

BROOKSHIRE
partial overlay



CARMIN
full overlay



CARMIN
full overlay
5-piece drawer option



CARMIN ARCH
full overlay



CORTLAND •
full overlay



CORTLAND •
full overlay
5-piece drawer option



CORTLAND ARCH •
full overlay



GALENA •
full overlay



GALENA •
full overlay
5-piece drawer option



HARMONY •
partial overlay



HARMONY ARCH •
partial overlay



HUXLEY
full overlay

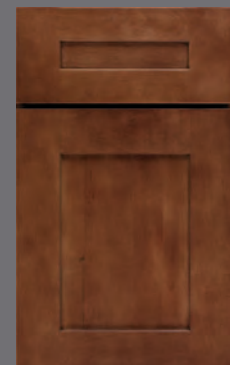

HUXLEY
full overlay
5-piece drawer option

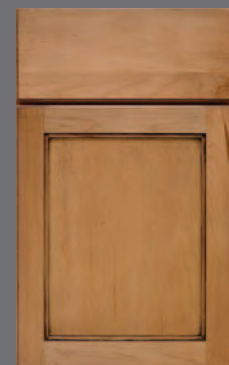

MORGAN
full overlay



PARKER •
full overlay



PARKER •
full overlay
5-piece drawer option



PARKER ARCH •
full overlay



PLEASANT HILL
full overlay



PLEASANT HILL
full overlay
slab drawer option

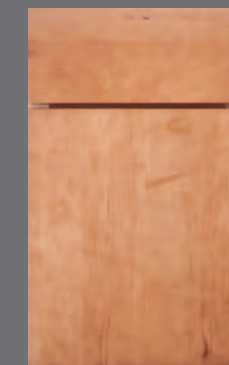

PRESTLEY
full overlay



PRINCETON
partial overlay



PRINCETON ARCH
partial overlay



WHITTAKER
full overlay

Considered one of the finest cabinetry woods available, Cherry is appreciated for its elegant grain pattern and rich reddish color, which may vary from pale red-gold to deep cinnamon. Cherry darkens naturally as it ages.



ASBURY •
full overlay



BRANTLEY
full overlay



BRINKMAN •
partial overlay



BRINKMAN •
partial overlay
raised drawer option



BRINKMAN ARCH •
partial overlay



CARMIN
full overlay



CARMIN
full overlay
5-piece drawer option



CARMIN ARCH
full overlay



ESSENCE •
partial overlay



ESSENCE ARCH •
partial overlay



GALENA •
full overlay



GALENA •
full overlay
5-piece drawer option

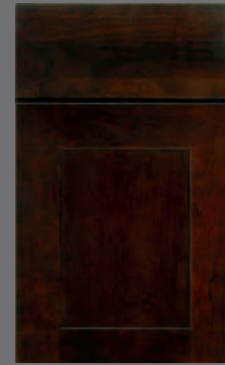

HUXLEY
full overlay

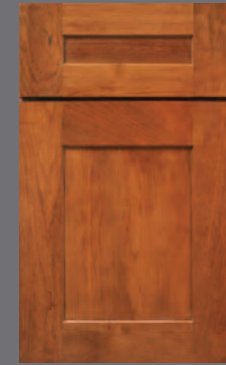

HUXLEY
full overlay
5-piece drawer option

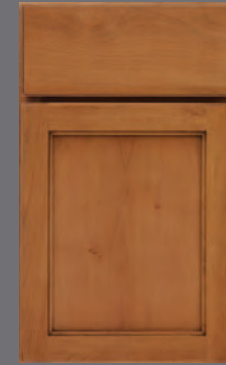

MORGAN
full overlay



PARKER •
full overlay



PARKER •
full overlay
5-piece drawer option



PARKER ARCH •
full overlay



PLEASANT HILL
full overlay



PLEASANT HILL
full overlay
slab drawer option



PRESTLEY
full overlay



PRINCETON
partial overlay



PRINCETON ARCH
partial overlay



WHITTAKER
full overlay

OAK

Oak has a bold, strong and open-grain pattern and warm natural color ranging from salmon red to dark cinnamon within a panel. Oak doors may include random wormholes, knots and wild grain patterns.



BRINKMAN •
partial overlay

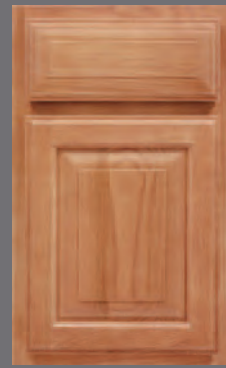

BRINKMAN •
partial overlay
raised drawer option

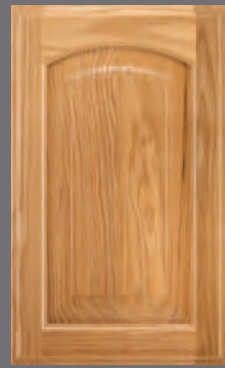

BRINKMAN ARCH •
partial overlay



GENTRY •
full overlay



GENTRY ARCH •
full overlay



HAMPSHIRE
partial overlay

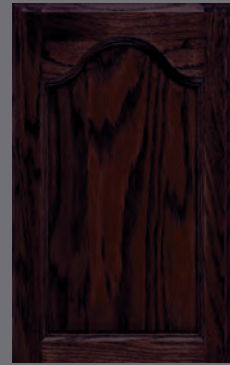

HAMPSHIRE CATHEDRAL
partial overlay

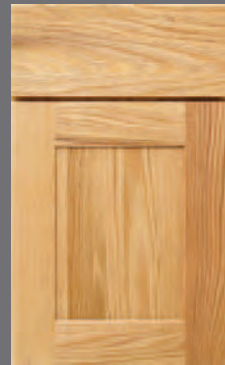

HUXLEY
full overlay

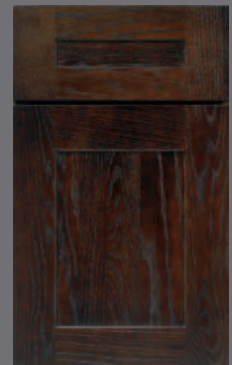

HUXLEY
full overlay
5-piece drawer option



NOBLE •
partial overlay

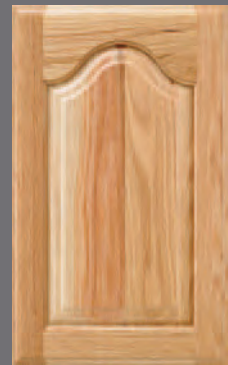

NOBLE CATHEDRAL •
partial overlay



STRATFORD
partial overlay



STRATFORD CATHEDRAL
partial overlay

ALDER & RUSTIC ALDER

• distressing finish technique available

Alder is a softer wood than maple and cherry and can dent relatively easily, but offers a stable surface for stain. Both Alder and Rustic Alder's appearance can range from pale red to reddish brown. Rustic Alder will vary from rustic, with heartwood, mineral deposits, pin holes and sound, cracked or open knots, to relatively clear and unmarked.

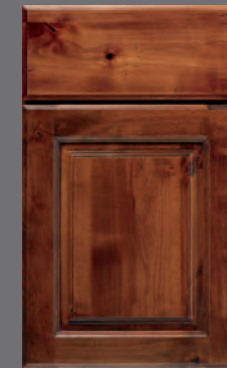

CHANLEY •
full overlay



CHANLEY •
full overlay
5-piece drawer option



GALENA •
full overlay
available on alder only



GALENA •
full overlay
5-piece drawer option
available on alder only



HARPER •
partial overlay

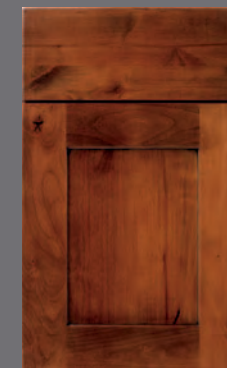

HUXLEY
full overlay

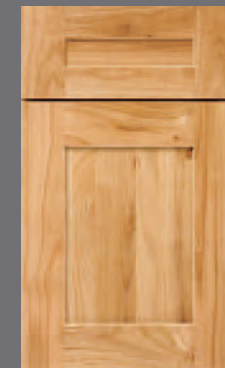

HUXLEY
full overlay
5-piece drawer option



MORGAN
full overlay

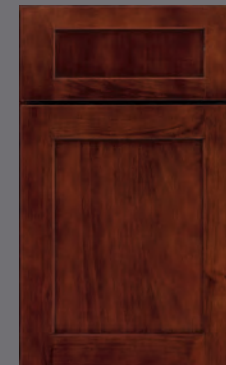

PLEASANT HILL
full overlay



PLEASANT HILL
full overlay
slab drawer option

PURESTYLE™ LAMINATE

PureStyle Laminate displays the precision of a paint, with the durability of a laminate. PureStyle provides the sensibility of those who care about creating a better environment – inside and outside their home.



FENMORE
full overlay



FENMORE
full overlay
slab drawer option



LAMONT
full overlay

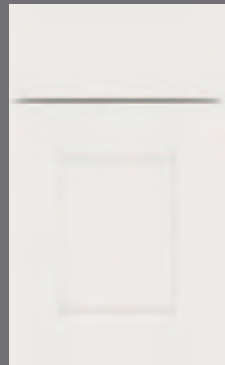

MORAVIA
full overlay

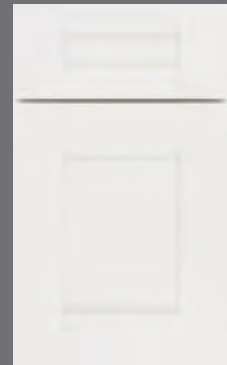

MORAVIA
full overlay
5-piece drawer option

HICKORY

• distressing finish technique available

Its strong grain pattern is marked by vividly contrasting colors in tones from pale gold to deep chocolate brown, and random markings such as knots and wormholes add textural interest.



PLEASANT HILL
full overlay



PLEASANT HILL
full overlay
slab drawer option



PALMER •
partial overlay



PALMER CATHEDRAL •
partial overlay

THERMOFOIL

Sleek and smooth-surfaced, thermofoil offers a sophisticated appearance along with exceptional durability and ease of maintenance for today's hard-working kitchen. White and Cashmere color may change slightly over time, depending on environmental conditions.



CELESTE
full overlay



REFLECTION
full overlay



SEVILLE
full overlay

HEIRLOOMING & DISTRESSING TECHNIQUES

HEIRLOOM

Add character and depth to select finishes with over-sanding on edges and profiles for a naturally worn-to-the-wood appearance that says old world charm. Available in the following finishes: Black, Honeysuckle, Juniper Berry, Moss, Oasis, Portobello, Sand Dune, Storm and Tidal Mist. See your dealer for availability on trim pieces.

DISTRESSING

Our distressing technique creates a finish with unique and appealing imperfections, such as dents, wormholes, chisel marks and other natural wear signs. Available on solid raised panel doors: Ainsley, Asbury, Brinkman, Carmin, Cortland, Galena, Harmony, Essence, Parker Chanley, Harper, Palmer, Gentry and Noble. Not available on Coconut, Dover, Pearl or White.

MAPLE



CHERRY



• Not available on Prestley



OAK

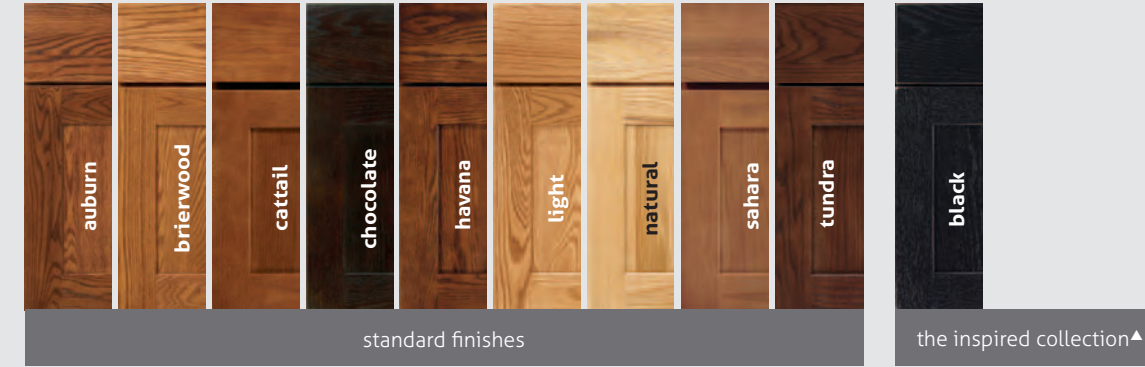

▲ Heirloom available



- Not available on Prestley
- Not available on Ainsley
- ▲ Heirloom available
- + Heirloom not available on White

HICKORY

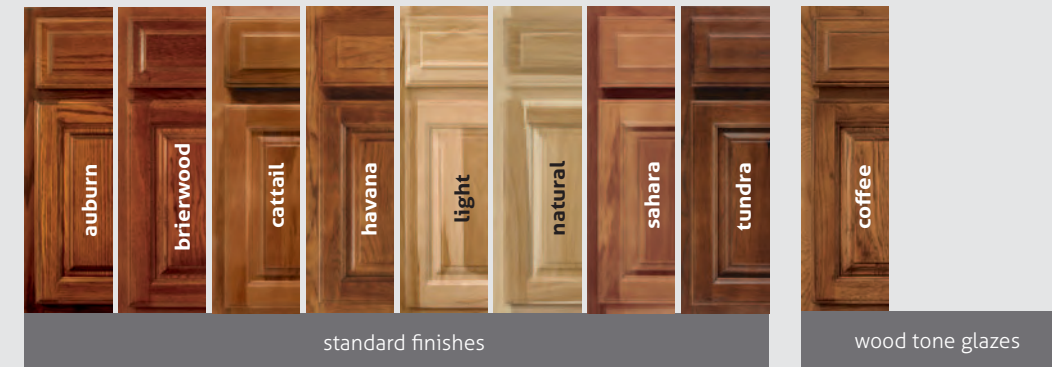

ALDER / RUSTIC ALDER



PURESTYLE™ LAMINATE



- Not available on Lamont
- Only available on Lamont

THERMOFOIL



* Only available on Seville

THE SCHROCK DIFFERENCE

SOLID INTEGRATED BACKS

allow the entire cabinet back to become a hanging rail for easy installation, are secured to sides with a strong and deep rabbet joint for stability, attach to the sides the entire length of cabinet for extra durability, and allow for wall cabinet size modifications without center stiles.

1/2" SIDES, TOPS & BOTTOMS

make our cabinets stronger, able to bear more weight, and provide ample glue surface to securely attach adjacent cabinets and countertops.

I-BEAM BRACES

help ensure square and level installation, add cabinet durability during the shipping process, and provide an attachment area for screw-on countertops.

SOLID WOOD, FULL EXTENSION, DOVETAIL DRAWER WITH SMART STOP™ GUIDES

offer extreme built-in value with beautifully crafted solid wood box drawer, dovetail joinery, and full-extension self-closing Smart Stop™ drawer system that allows easy access to everything within drawers.



CABINET BOX OPTIONS

STANDARD: FURNITURE BOARD

- 1/2" furniture board sides and bottom
- 3/8" solid furniture board I-beam brace dadoed into face frame, sides and back
- 3/8" solid furniture board integrated back
- 3/4" solid hardwood face frame
- Fully concealed, 6-way adjustable hinge
- Exterior sides laminated to match the selected finish, except The Inspired Collection finishes
- Cabinet interiors are laminated natural maple or white

UPGRADE 1: PLYWOOD ENDS

- Replaces standard cabinet sides with unfinished 1/2" plywood ends
- Exterior sides unfinished

UPGRADE 2: ALL PLYWOOD BOX

- Replaces standard cabinet construction with unfinished 1/2" plywood and shelves to 3/4" laminated plywood
- Exterior sides unfinished

UPGRADE 3: FURNITURE FINISHED ENDS

- Replaces standard cabinet sides with 3/4" finished veneer plywood ends to achieve a furniture-like appearance
- Exterior sides finished to match the selected finish, including Inspired Collection finishes

WITH SCHROCK, SMART STOP™ IS STANDARD



DRAWER: FULL EXTENSION GUIDE WITH SMART STOP™

- Full extension undermount guides with fast-clip removal system
 - 4-sided, clear-coated, solid wood
 - 3/4"* dovetail sides with 1/4" laminated plywood bottom
- * 3/4" prior to final processing; actual final dimensions may vary.



DOOR: INTEGRATED SMART STOP™ HINGE

- Smart Stop™ door system providing gentle, controlled self-closing feature that engages when the door is near the cabinet face frame
- Mechanism can be turned off with a flip of a switch



SLIDING SHELVES: FULL EXTENSION GUIDE WITH SMART STOP™

- Full extension undermount guides with fast-clip removal system
- 4-sided, clear-coated, solid wood
- 3/4"* dovetail sides with 1/4" laminated plywood bottom

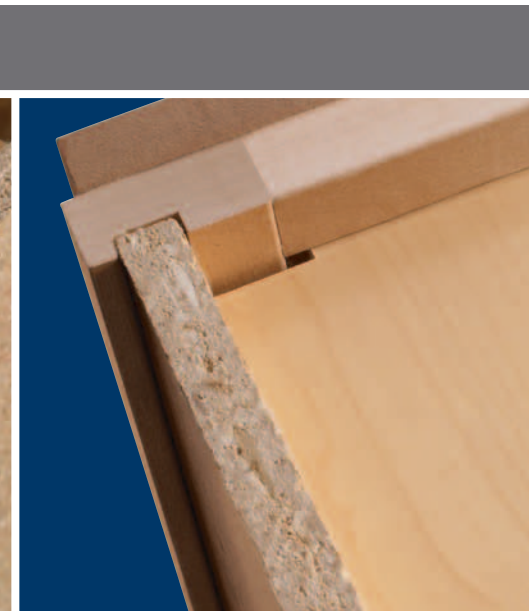

SHELF OPTIONS



STANDARD: ADJUSTABLE FURNITURE BOARD SHELVES

- ¾" adjustable furniture board shelving



UPGRADE*: ADJUSTABLE PLYWOOD SHELVES

- Replaces standard shelves with ¾" veneer plywood shelves

* Must upgrade to All Plywood Construction (APC) to get this feature



VALUE OPTION: DRAWER



¾ EXTENSION UNDERMOUNT GUIDE

- Replaces full extension and Smart Stop with ¾ extension

VISIT US AT: SCHROCK.COM

YOUR ONLINE CABINETRY PLANNING SOLUTION

- View the complete line of Schrock Cabinetry
- Kitchen, bath & other room photo gallery
- Project planning and more



SLIDING SHELF OPTION



UPGRADE: EASYTRAX™ SLIDING SHELVES

- All standard features plus EasyTrax™ features. Allows for easy height adjustment of sliding shelves.

CABINET NOMENCLATURE

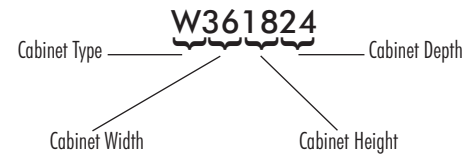

The cabinets listed below, and in the following pages, represent a sampling of our most popular cabinets. See your kitchen and bath designer for our full-line of cabinets and their specifications.

Here are some things to keep in mind when choosing your cabinets:

- For Single Door Cabinets, specify L or R hinging.
- All Standard Base Cabinets are available in Square door styles only.
- Vanity Utility Cabinets have the option for top door Arch and bottom door Square if specified.

Standard Depths and Heights (unless otherwise noted):

- Wall Cabinet Depth is 12".
- Base Cabinet Depth is 24", Height 34 1/2".
- Tall Cabinet Depth is 12" or 24".
- Vanity Cabinet Depth is 18" or 21", Height 32" or 34 1/2".

CUT FOR GLASS SPECIALTY DOORS*

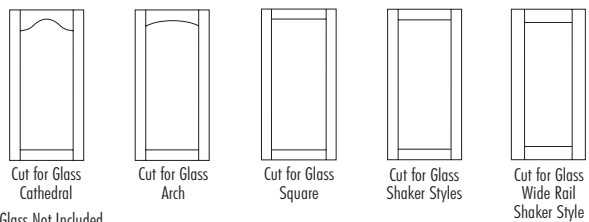

*Glass Not Included.

MULLION SPECIALTY DOORS*

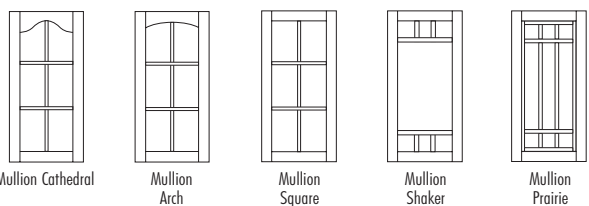

*Tempered Clear Glass Included.

WALL SINGLE DOORS

A Wall Single Door	W9** L or R W12** L or R	W15** L or R W18** L or R W21** L or R W24** L or R
B Wall Single Door Top Hinge	WTH30**	WTH36**
C Wall Easy Access Storage Cabinet		WEAS**30 L or R

WALL DOUBLE DOORS

A Wall Double Door	W24** W27**	W30** W33**
B Wall Double Door	W39**	W42** W48** W48**CS
C Wall Easy Access Storage Cabinet		WEAS**30

WALL REFRIGERATOR OPTIONS

A Wall Refrigerator	W***24	W***24 L or R
B Wall Refrigerator Single Door Top Hinge	WTH30**24	WTH36**24
C Wall Refrigerator w/Shelf	W**2424 L or R	W**2424

WALL TWO DRAWER / WALL THREE DRAWER

A Wall Two Drawer	W2D**18	W2D15** L or R	W2D18** L or R	W2D24** L or R	W2D24**	W3D15** L or R	W3D18** L or R
B Wall Two Drawer w/Tiered Insert	W2D**18TI						
C Wall Two Drawer Single Door							
D Wall Two Drawer Double Door							
E Wall Two Drawer Single Door w/Tiered Insert	W2D15**TI L or R	W2D18**TI L or R	W2D24**TI L or R				
F Wall Two Drawer Double Door w/Tiered Insert	W2D24**TI						
G Wall Three Drawer Single Door	W3D15** L or R	W3D18** L or R	W3D24** L or R				
H Wall Three Drawer Double Door	W3D24**						

TIP: Great for plastics container storage. Store bowls above and organize lids in drawers below.

STACKED WALL CABINETS / STACKED DIAGONAL WALL CABINETS

A Stacked Wall Cabinets	STW*** L or R
B Stacked Diagonal Wall	STDW***** L or R

WALL CORNER OPTIONS

A Wall Corner	WC*** L or R	DW***** L or R	DW*****T L or R	ER** L or R	ER**2121 L or R	ER***** L or R	W***COA	W12**COA
B Diagonal Wall						DW**2424P**		W***CIA
C Diagonal Wall w/Tambour								
D Diagonal Wall w/Lower Door								
E Easy Reach Wall Corner								
F Asymmetrical Easy Reach Wall Corner								
G Diagonal Wall Peninsular								
H 135 Degree Corner Outside Wall								
I 135 Degree Corner Inside Wall								

TIP: Keep small items out of sight with the "appliance garage" tambour door.

Available in square only.

WALL LAZY SUSANS

A Diagonal Wall w/Lazy Susan	DW**2424S L or R	DW**2424S L or R
B Diagonal Wall w/Tambour and Lazy Susan	DW**2424S L or R	DW**2424S L or R
C Diagonal Wall w/Lower Door and Lazy Susan	DW**2424S L or R	DW**2424S L or R

WALL END OPTIONS

A Wall End Cabinet	WEC12** L or R	WTC1230**	WMC12** L or R
B Wall End Cabinet Double Door	WEC12**D	WTC1233**	
C Wall Transition Cabinet	WTC1236**	WTC1239**	
	WTC1242**		
D Wall Message Center			

WALL END OPTIONS

A Wall Quarter Round End Shelves, Radius Top & Bottom Panels	WQRES6**RT	WQRES6**ST L or R	WQRES6**STSB	WQRES12**RT	WQRES12**STRB
B Wall Quarter Round End Shelves, Square Top & Radius Bottom Panels					
C Wall Quarter Round End Shelves, Square Top & Bottom Panels					
D Wall Quarter Round End Shelves, Radius Top & Bottom Panels					
E Wall Quarter Round End Shelves, Square Top & Radius Bottom Panels					
F Wall Quarter Round End Shelves, Square Top & Bottom Panels					

WALL MICROWAVE CABINETS

A Wall Microwave Cabinet	MW**18	MW**21
B Wall Microwave Double Door Cabinet		MW**36
C Wall Built-in Microwave Cabinet	WBMW27**18	WBMW27**21
	WBMW30**18	WBMW30**21

WALL ORGANIZER CABINET & WALL SPICE RACKS

A Wall Cookbook and Recipe Organizer	WCRO2130 L or R
B Wall Spice Rack Cabinet	WSR18** L or R
	WSR21** L or R

CUTLERY DIVIDERS, TAMBOURS, WALL APPLIANCE GARAGE DOOR, WALL CORNER CABINETS, & SPICE DRAWERS

A Cooking Utensil Divider	CUDD**	CIW**	TCDD**	WAGD** L or R	CT**	CD** L or R	ST**	BSD6	WSD**
B Cutlery Insert Wood Organizer									
C Cutlery Divider, Tiered									
D Wood Tiered Cutlery Divider Drawer	WTCDD**								
E Wall Appliance Garage Door									
F Corner Tambour									
G Corner Door									
H Straight Tambour									
I Base Spice Cabinet w/Drawers									
J Wall Spice Drawer									

WALL/BASE PULL-OUT STORAGE

A Base Pantry Pull-Out	BBCPO*	WBCPO*30	WSP9**
B Base Box Column Pull-Out	BBCPO**FF	WBCPO*30FF	WSP12**
C Wall Box Column Pull-Out			
D Wall Spice Pull-Out			

WALL OPEN CABINETS WITH BEADED BACK & VALANCE



Specify valance type by adding appropriate letters to end of model number.

	A with Arched Valance	B with Furniture Valance	C with Straight Valance
Wall Open Cabinet w/Beaded Back and Valance	WOC24** WOC30** WOC36**	AV AV AV	FV FV FV
		VV VV VV	

WALL CHINA & WINE CABINETS

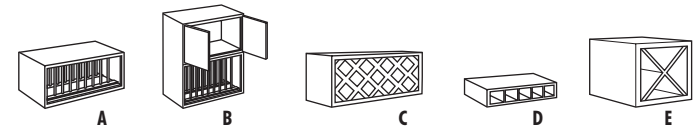

A Wall China Display	WCD**15
B Wall China Display w/Doors	WCD****
C Wall Wine Rack	WNR****
D Wall Wine Cubby	W6**
E Wine Storage Cabinet	WSC1818**

RACKS & SHELVES

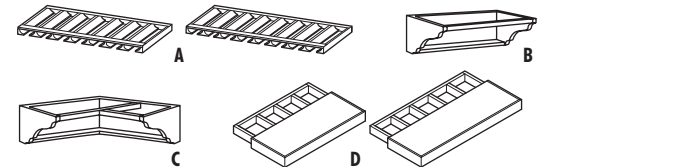

A Wine Glass Holder	WGH**
B Wall Decorative Shelf	WS**
C Wall Corner Decorative Shelf	WCS2424
D Floating Shelves	FS**

WALL WOOD HOODS*

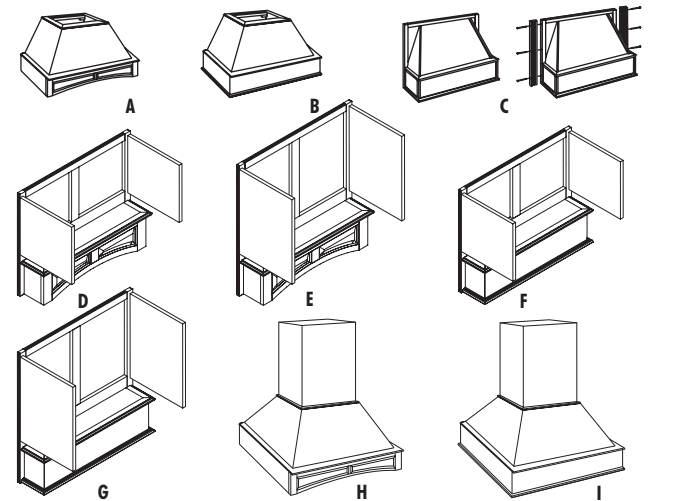

A Wood Hood Arch	WHA**
B Wood Hood Square	WHS**
C Tapered Wood Hood	TWH**
D Wood Hood Canopy Arched	WHCA**
E Wood Hood Canopy Arched, 30" High	JWHCA**30
F Wood Hood Canopy Square	WHCS**
G Wood Hood Canopy Square, 30" High	JWHCS**30
H Wood Hood Island Arch	JWHIA**
I Wood Hood Island Square	JWHIS**

*Wood hoods do not come with blower kits, order separately.

HEARTHES

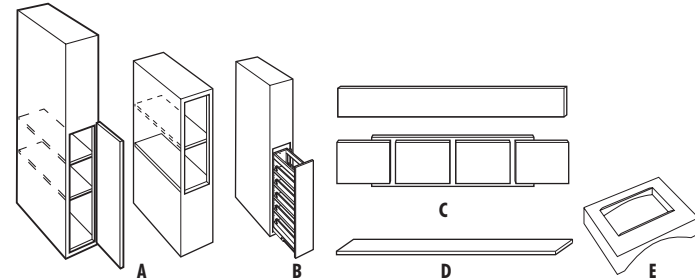

A Hearth Pier	HP9**21 L or R	HP93621
B Hearth Pier w/Pull-Out		HP99**21
C Hearth Mantel	HM**6 HM**9 HM**12	HM**15 HM**18 HM**24
D Hearth Shelf		HS**
E Hearth Liner		HL**

BASE SHELF CABINETS

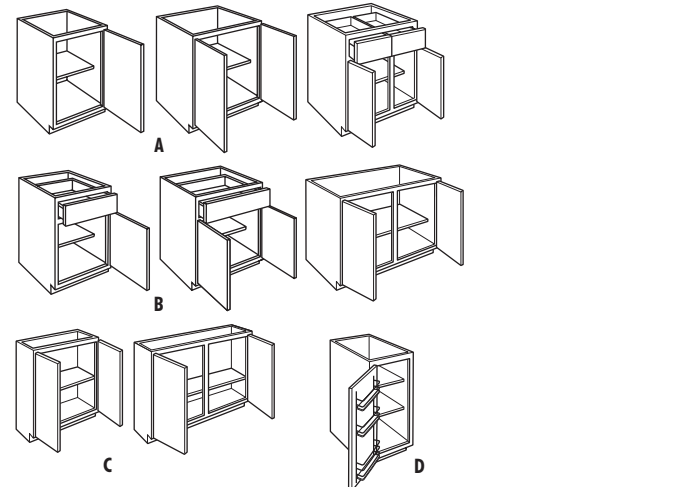

A Full Height Door Base Cabinet	B**FH L or R B**40FH L or R	B**FH B**40FH	B48FHCS B4840FHCS
B Base Cabinet	B** L or R	B**	B**CS
C Wall Base Double Door		WB**	WB48CS
D Base Easy Access Storage Cabinet			BEAS** L or R

BASE POTS, PANS, & BAKING DISHES CABINETS

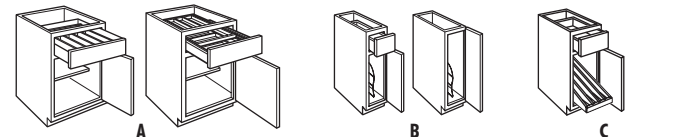

A Base w/Cutlery Insert Wood Organizer w/Wood Tiered Cutlery Divider Drawer	B**CIW L or R B**WTCD L or R	B24CIW B24WTCD
B Base w/Tray Divider w/Full Height Door		TD** L or R TD**FH L or R
C Base w/Roll-Out Tray Divider		B**TDRO L or R

BASE POTS, PANS, & BAKING DISHES CABINETS

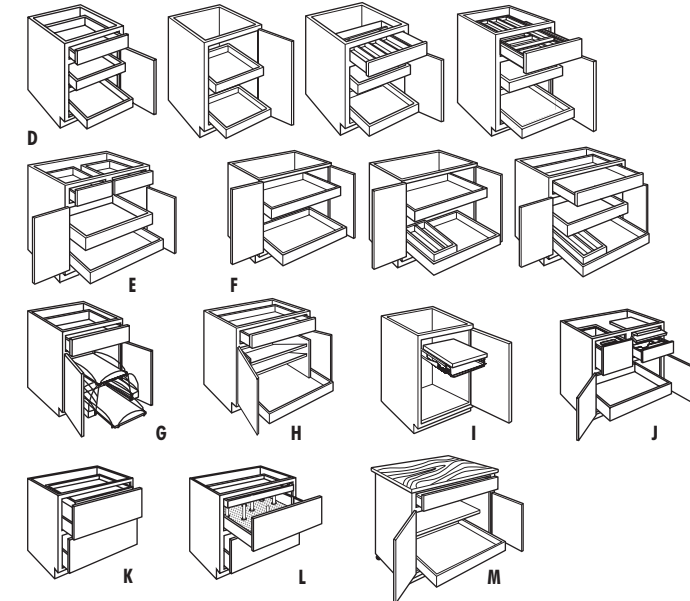

D Sliding Shelf Base w/2 Sliding Shelves (Accommodates up to 2 extra sliding shelves.)	B**SS L or R	B**SS
w/Full Height Door	B**40FHSS L or R	B**40FHSS
w/Cutlery Insert Wood Organizer (Accommodates up to 2 extra sliding shelves.)		B**SSCIW L or R B24SSCIW
w/Wood Tiered Cutlery Divider Drawer	B**SSWTCD L or R	B24SSWTCD
E Sliding Shelf Base Buffet		B**SSB
F Sliding Shelf Full Height Base w/2 Sliding Shelves w/Lid Organizer (Accommodates up to 3 extra sliding shelves.)		B**FHSS B**FHSSLO
w/Drawer and Lid Organizer (Accommodates up to 2 extra sliding shelves.)		B**SSLO
G Base Pots and Pans Pull-Out	B24PS L or R	BPPP**
H Pots & Pans Organizer Base w/Drawer	B24PS L or R	B**PS
I Base Cabinet w/Mixer Shelf		B**FHMIX L or R B24FHMIX
J Base Cooking Center (Includes bread board, tiered cutlery insert, and bread box lid.)		BCC**
K Two Drawer Base w/Sliding Shelf		2DB**SS
L Two Drawer Base w/Sliding Shelf and Pegged Dish Organizer		2DB36SSPDO
M Floating Island Base		FIC**

*Order extra sliding shelves separately.

BASE SUPERCABINET™

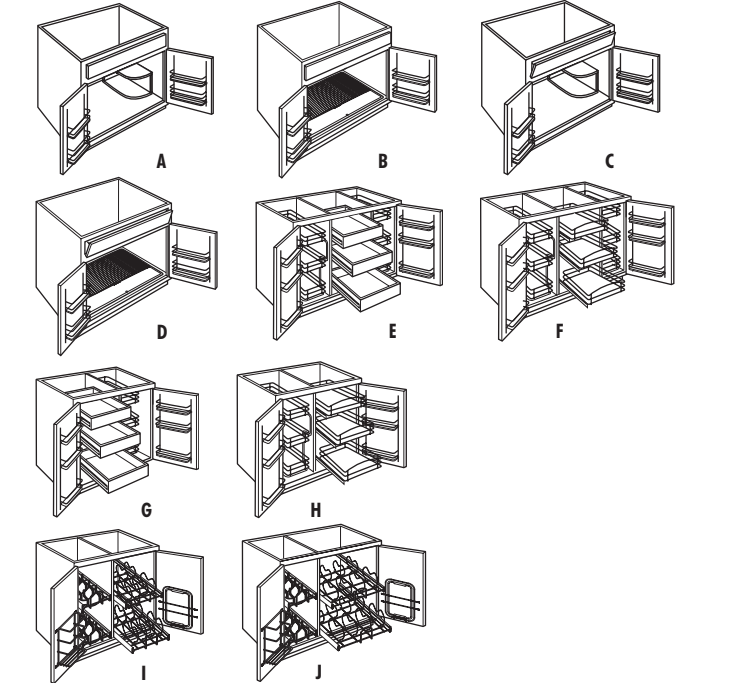

A Sink Base SuperCabinet™	SB**S
B Sink Base SuperCabinet™ w/CabMat	SB36SCM
C Sink Base SuperCabinet™ w/Tilt Downs	SB**STS
D Sink Base SuperCabinet™ w/Tilt Downs and CabMat	SB36STSCM
E 36" SuperCabinet™	BSC36****
F 36" SuperCabinet™ Version 2	BV2SC36****
G 30" SuperCabinet™	BSC30**
H 30" SuperCabinet™ Version 2	BV2SC30**
I 30" SuperCabinet™ Gourmet	BSCG30 L or R
J 36" SuperCabinet™ Gourmet	BSCG36 L or R

SINK BASES

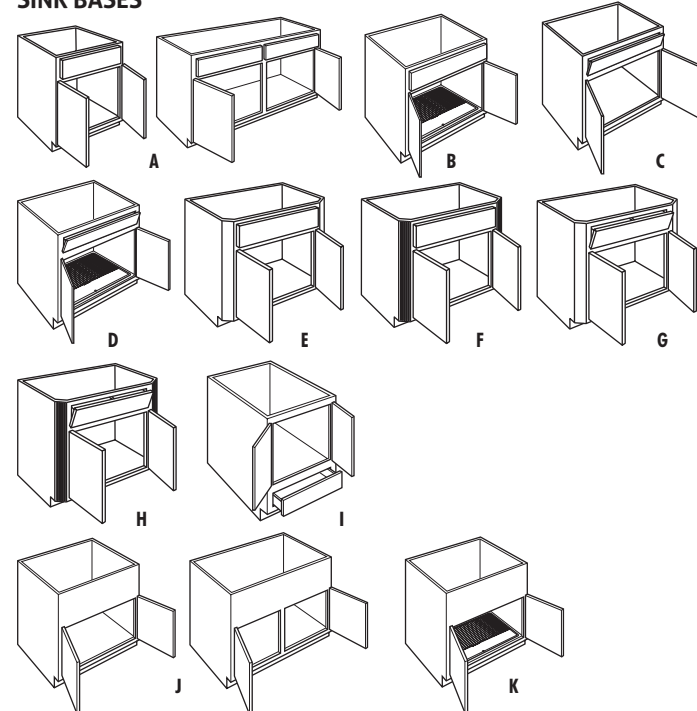

A Sink Base	SB** L or R SB** SB48CS	SB243427 L or R SB**3427 SB483427CS
B Sink Base w/CabMat		SB36CM
C Sink Base w/Tilt Downs	SB**ST	SB**3427ST
D Sink Base w/Tilt Downs and CabMat		SB36STCM
E Sink Base w/Clipped Corners, Plain		SB**3427CC
F Sink Base w/Clipped Corners, Fluted		SB**3427FCC
G Sink Base w/Clipped Corners and Tilt Downs, Plain		SB**3427CCST
H Sink Base w/Clipped Corners and Tilt Downs, Fluted		SB**3427FCCST
I Sink Base w/Drawer Below	SB24D L or R	SB**D
J Country Sink Base	CNTYSB**	CNTYSB48CS
K Country Sink Base w/CabMat		CNTYSB36CM

CORNER SINK BASES

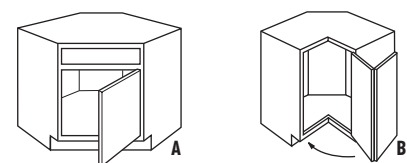

A Angled Corner Sink Base	ACS** L or R	ACS42
B Square Corner Sink Base		CS** L or R

BASE CORNER OPTIONS

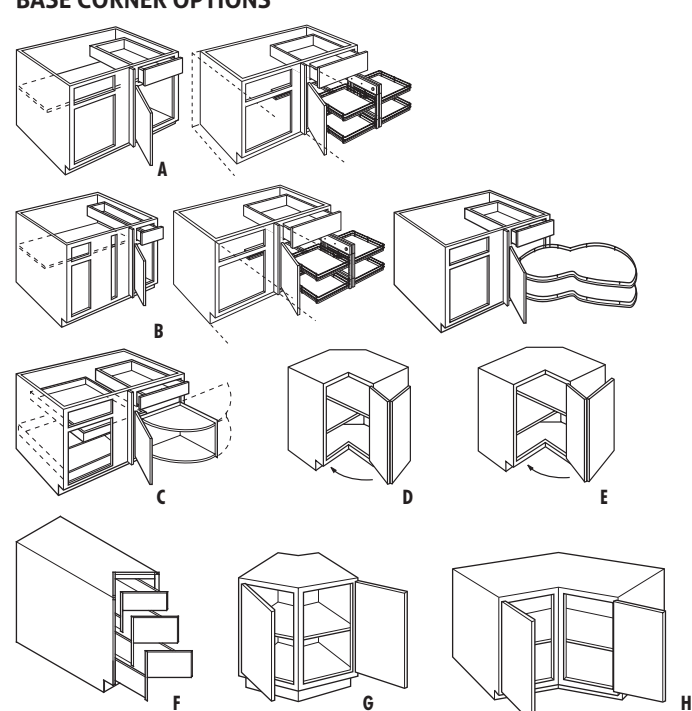

A Base Corner w/Pull-Out	BC** L or R	BC**PO L or R
B Base Corner Full Width w/Pull-Out	BCFW** L or R	BCFW**PO L or R
C Base Corner Full Width w/Sliding Shelves and Swing-Out		BCFW48CPO L or R
D Base Easy Reach		BER** L or R
E Asymmetrical Base Easy Reach		BER*** L or R
F Three Drawer Corner Cabinet		3CDB36
G 135 Degree Corner Outside Base	BFH*COA	BFH12COA
H 135 Degree Corner Inside Base		BFH***CIA

BASE LAZY SUSANS

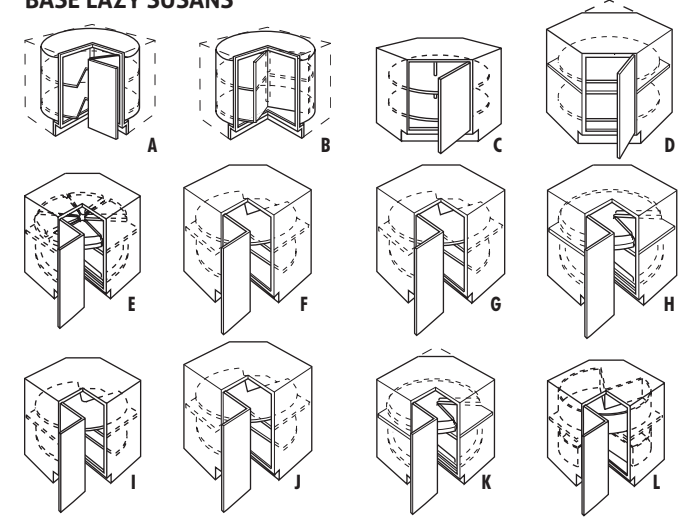

A Base Lazy Susan Corner w/Full Height Center Hinged Door	BLS36 L or R
B Base Lazy Susan Corner w/Revolving Door	BLS36DR
C Diagonal Base w/Full Height Door and Lazy Susan	DAB36S L or R
D Diagonal Base w/Full Height Door and Super Lazy Susan	DAB36SLS L or R
E Segmented Super Lazy Susan	SSS36 L or R
F Asymmetrical Super Lazy Susan	SLS*** L or R
G Asymmetrical Solid Wood Super Lazy Susan	SLSW*** L or R
H Asymmetrical Super Lazy Susan w/Chrome Rail	SLSCR*** L or R
I Super Lazy Susan	SLS** L or R
J Solid Wood Super Lazy Susan	SLSW** L or R
K Super Lazy Susan w/Chrome Rail	SLSCR** L or R
L Base Rotating Deep Bin	BRDB36 L or R

BASE END OPTIONS

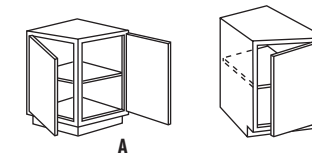

A Base End Cabinet	BEC24
B Base Transition Cabinet	BTCL2**

BASE POTS, PANS, & BAKING DISHES CABINETS

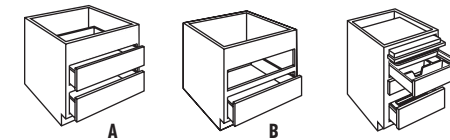

A Two Drawer Base, Drop-in Range	2DB**DR
B Two Drawer Base, Drop-in Range and Warming Drawer	2DB**DRWD
C Three Drawer Base Special	3DB**SP

(Includes bread board, tiered cutlery insert, and bread box lid.)

DRAWER BASE CABINETS

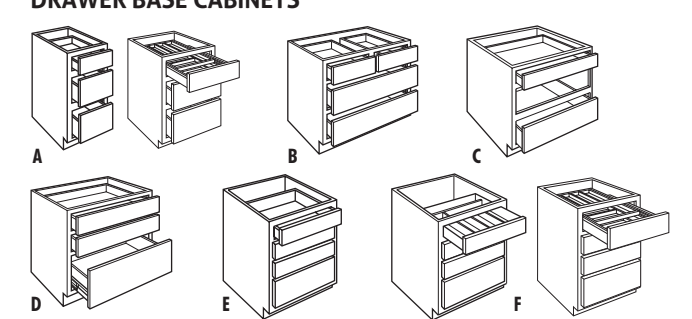

A Three Drawer Base w/Wood Tiered Cutlery Divider Drawer	3DB**
B Three Drawer Base Buffet	3DBB**
C Three Drawer Base, Warming Drawer	3DB**WD
D Three Drawer Base w/Deep Drawer	3DB**DD
E Four Drawer Base	4DB**
F Four Drawer Base w/Cutlery Insert Wood Organizer w/Wood Tiered Cutlery Divider Drawer	4DB**CIW 4DB**WTC

BASE WASTE CABINETS

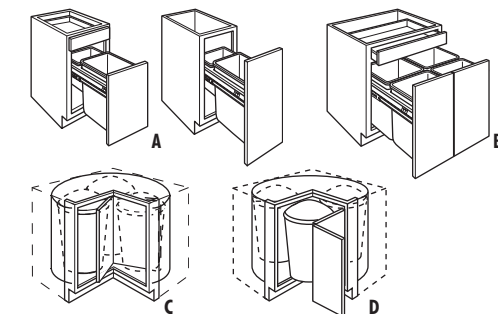

A Base Wastebasket w/Full Height	BWB**
B Base Recycling Center	BRC27
C Recycling Trash Base w/Revolving Door	RRC36DR
D Recycling Trash Base w/Center Hinged Door	RRC36 L or R

BASE OPEN BASKET WITH BEADED BACK & VALANCE

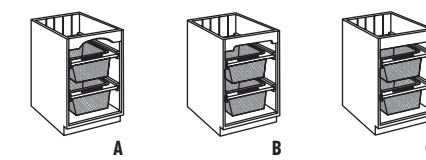

Specify valance type by adding appropriate letters to end of model number.		A with Arched Valance	B with Furniture Valance	C with Straight Valance
Base Open Basket Cabinet w/Beaded Back and Valance	BOB**	AV	FV	WV

BASE END OPTIONS

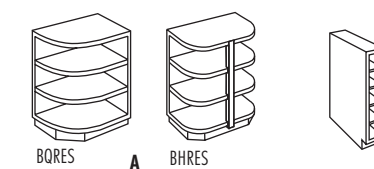

A Base End Shelves	BORES	BHRES
B Base Wine Cubby (Holds 5 bottles.)		BWC6

BASE OVEN & MICROWAVE CABINETS

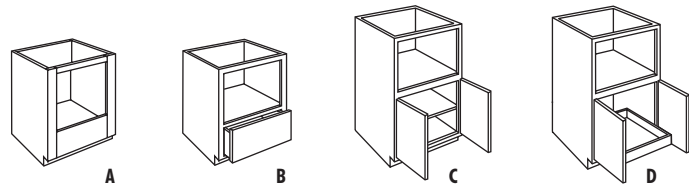

A Base Oven Cabinet	BO**
B Base Microwave Cabinet w/Drawer	BMW**34
C Base Microwave Cabinet	BMW2448 L or R BMW**48
D Base Microwave Cabinet w/Sliding Shelf	BMW2448SS L or R BMW**48SS

DISHWASHER

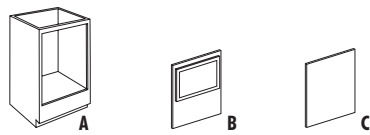

A Base Dishwasher Cabinet	BDW2748
B Dishwasher Door Kit	DWD
C Dishwasher Front Panel	DWPWD DWPPLM18

BASE CORNER PENINSULA OPTIONS

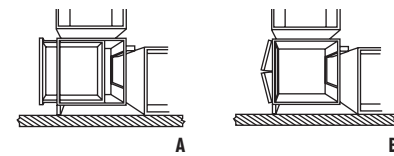

A Base Corner Peninsula w/Shelf and Drawer	BCP24
B Base Corner Peninsula w/Shelf and Full Height Doors	BCP24FH

BASE OPEN CABINETS WITH BEADED BACK & VALANCE

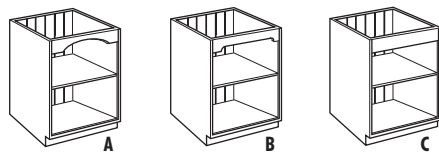

Specify valance type by adding appropriate letters to end of model number.

Base Open Cabinet w/Beaded Back and Valance	BOC**	A with Arched Valance	B with Furniture Valance	C with Straight Valance
		AV	FV	VV

BASE OPEN WITH BEADED BACK, DRAWER & VALANCE

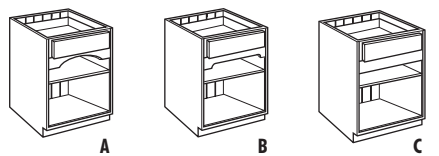

Specify valance type by adding appropriate letters to end of model number.

Base Open Cabinet w/Beaded Back, Drawer and Valance	BOD**	A with Arched Valance	B with Furniture Valance	C with Straight Valance
		AV	FV	VV

TALL UTILITY CABINETS

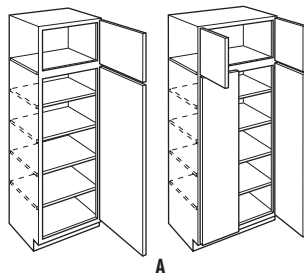

A Utility Cabinets	U***** L or R	U*****
---------------------------	---------------	--------

PANTRIES

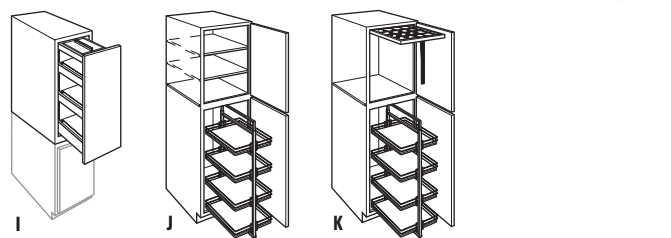
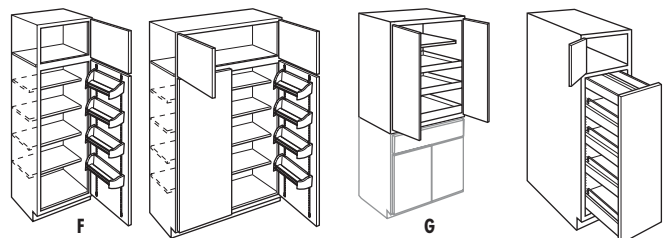
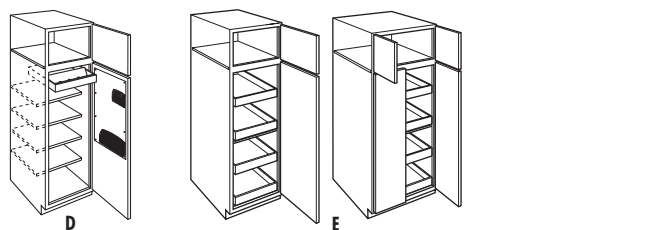
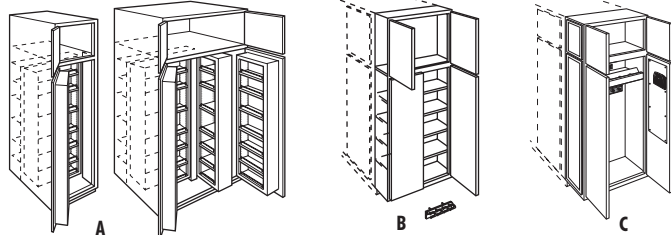

A Pantry Unit	PY18**24 L or R	PY36**24
B Utility Organizer Cabinet	UOC24**6	
C Utility Organizer Drop Zone Cabinet	UOCZ24**9AE*	
D Utility Drop Zone Cabinet	UDZ18**24 L or R	UDZ36**24
E Utility w/Sliding Shelves	U15**24SS L or R U18**24SS L or R U21**24SS L or R	U24**24SS L or R U30**24SS U33**24SS U36**24SS
F Utility Easy Access	UEAS****12 L or R UEAS****12	UEAS****24 L or R UEAS****24
G Pantry Top Unit	PTU30**24	PTU36**24
H Tall Pantry Pull-Out	TPP9**24 L or R TPP12**24 L or R	TPP15**24 L or R TPP18**24 L or R
I Pantry Top Unit w/Pull-Out		PTUP**4924
J Utility Storage w/Pantry Pull-Out		US***** L or R
K Utility Storage w/Pantry Pull-Out and Pot and Pan Rack		US*****PP L or R

TALL OVEN & MICROWAVE CABINETS

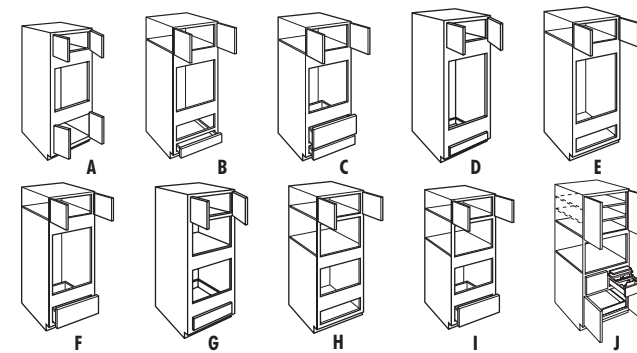

A Single Oven Cabinet	OCS****24
B Single Oven Cabinet, Warming Drawer	OCS****24WD
C Single Oven Cabinet, Deep Drawer	OCS****24DD
D Double Oven Cabinet	OCD****24
E Double Oven Cabinet, Warming Drawer	OCD****24WD
F Double Oven Cabinet, Deep Drawer	OCD****24DD
G Oven Microwave Cabinet	OMC****24
H Oven Microwave Cabinet, Warming Drawer	OMC****24WD
I Oven Microwave Cabinet, Deep Drawer	OMC****24DD
J Microwave Cooking Center (Includes bread board, cutlery insert, bread box lid, and 1 sliding shelf.)	MCC30**24

WALL BOOKCASES WITH MATCHING INTERIOR

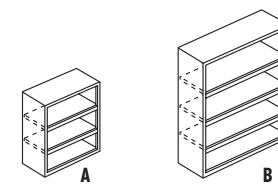

A Bookcase w/Matching Interior	W**30BC
B Bookcase w/Matching Interior	W**48BC

WALL BOOKCASES WITH VALANCE

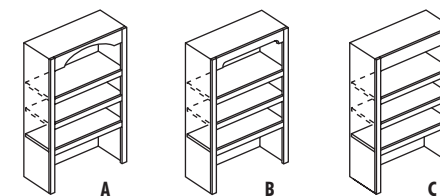

Specify valance type by adding appropriate letters to end of model number.

Wall Bookcase w/Valance	W****BC	A with Arched Valance	B with Furniture Valance	C with Straight Valance
		AV	FV	VV

TALL BOOKCASES WITH VALANCE

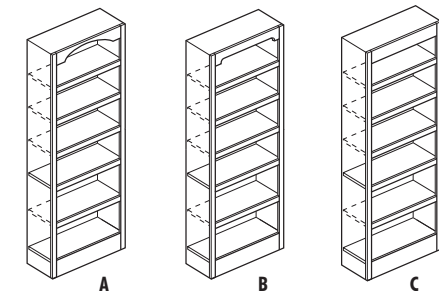

Specify valance type by adding appropriate letters to end of model number.

Tall Bookcase w/Valance	T****12BC T****18BC	A with Arched Valance	B with Furniture Valance	C with Straight Valance
		AV	FV	VV

TALL BOOKCASES WITH VALANCE AND DOORS

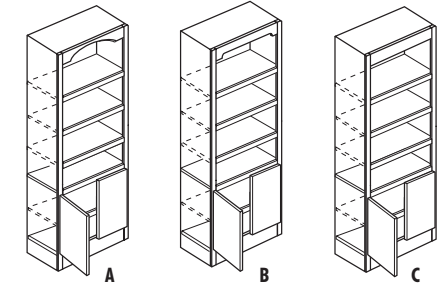

Specify valance type by adding appropriate letters to end of model number.

Tall Bookcase w/Valance and Doors	TD****12BC TD****18BC	A with Arched Valance	B with Furniture Valance	C with Straight Valance
		AV	FV	VV

BASE OFFICE FURNITURE

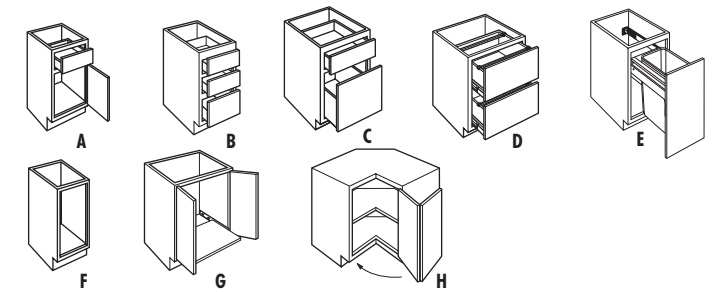

A Desk Door Drawer Base	DDO**29** L or R	DDO**29**
B Desk Drawer Base	DDR**2921	DDR**2924
C Desk File Drawer Base	DFD**2921	DFD**2924
D Desk Double File Drawer Base	DDFD2429**	DDFD3029**
E Desk Waste Basket Full Height Base		DWB*****FH
F CPU Base	CPU1229**	CPU1529**
G Printer Base	PRB242921	PRB242924
H Desk Easy Reach	DER33321 L or R	DER363624 L or R

FURNITURE DRAWERS, WOOD TOPS, & FILING SYSTEM HARDWARE KIT

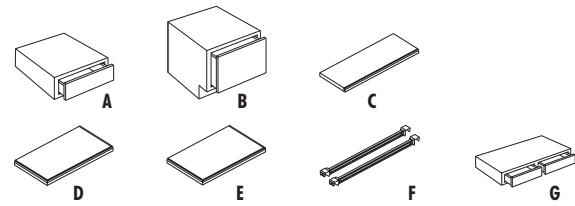

A Furniture Drawers	FD**0624	FD**1224
B Furniture Drawer Window Bench		FDWB**1824
C Wood Tops, One Sided	1TWT7221	1TWT7224
D Wood Tops, Three Sided	3TWT**21	3TWT**24
E Wood Tops, Four Sided	4TWT**27	4TWT**33
F Filing System Hardware Kit		FSHK**
G Under Counter Drawer	UCD**18	UCD**21

ORGANIZERS & KEYBOARD TRAY

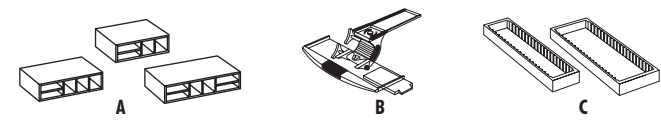

A Wall Organizer		WO**
B Keyboard Tray		KB17421
C CD and DVD Insert Kits	CDI**	DVDI**

VANITY BASE CABINETS

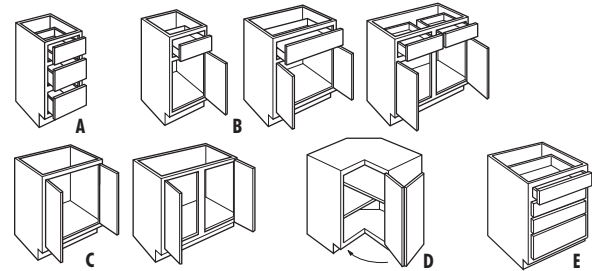

A Vanity Drawer Base	VDB****18	VDB****21
B Vanity Base w/Drawer	VB****18 L or R	VB****18
	VB****21 L or R	VB****21
	VB48****CS	
C Vanity Base	V****18 L or R	V****18
	V****21	V48****CS
D Vanity Base Easy Reach		VER**** L or R
E Vanity Four Drawer Base		4VDB**3421

VANITY SINK BASES

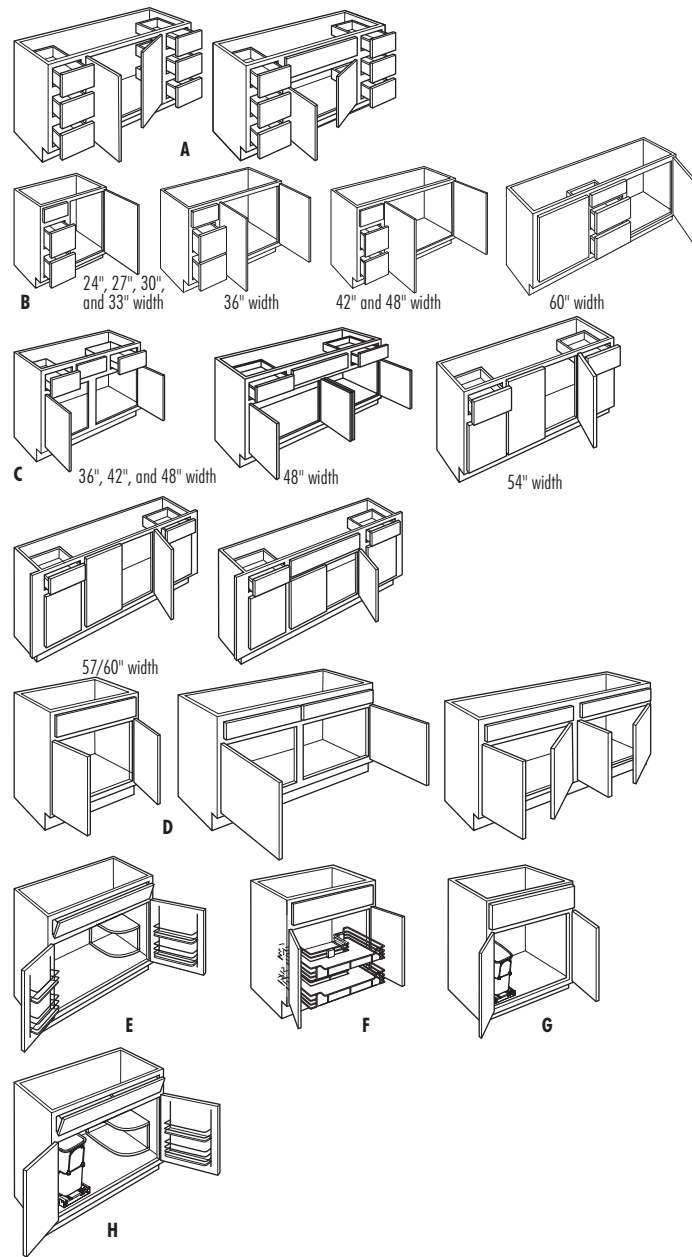

A Vanity Sink Drawer Base w/Six Drawers	6VSD*****	6VSD*****FP
B Vanity Sink Drawer Base	VSD***** L or R	VSD*****FP L or R
	VSD60****	VSD60****FP
C Vanity Sink Drawer Base	2VSD*****	2VSD57/60****
	2VSD*****FP	2VSD57/60****FP
	2VSD48****CS	
D Vanity Sink Base w/False Panels	VSB***** L or R	VSB****18
	VSB****21	VSB48****CS
E Vanity Sink Base SuperCabinet™ w/Tilt Downs		VSSB**3421ST
F Vanity Sink Base w/U-shaped Roll-Out Tray		VSB30**21U
G Vanity Sink Base w/Wastebasket		VSB**3421WB L or R
H Vanity Sink Base SuperCabinet™ w/Tilt Downs and Wastebasket		VSSB**3421STWB L or R

VANITY SPECIAL

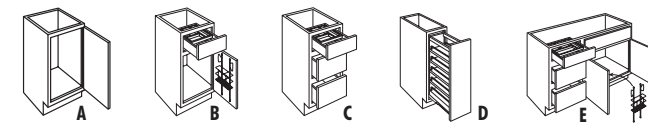

A Special Size Vanity	MV18**16 L or R
B Vanity Cosmetic Center Base	VCCB183421 L or R
C Vanity Cosmetic Center Drawer Base	VCCDB183421
D Vanity Pull-Out	VP93421
E Vanity Cosmetic Center Sink Drawer Base w/False Panel	VCC**3421FP L or R

LINEN CLOSETS

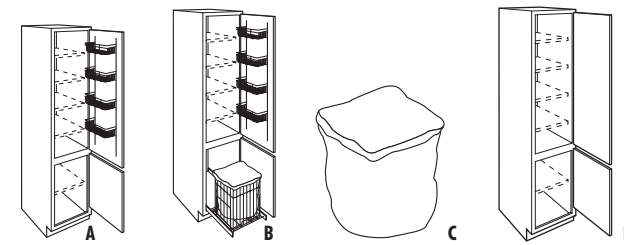

A Linen Closet	LC188421 L or R
B Linen Closet w/Removable Hamper	LCRH188421 L or R
C Linen Closet Hamper Liner	LCHAMPERLNR
D Linen Storage Cabinet	LT**84** L or R

VANITY UTILITY

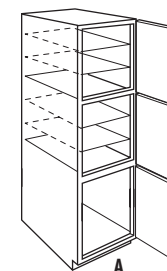

A Vanity Utility	VU188421 L or R
-------------------------	-----------------

WALL CABINETS & VANITY MIRROR

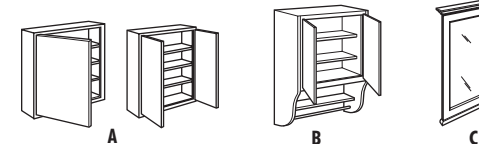

A Vanity Wall Cabinet	W**306 L or R	W24306
B Vanity Wall Towel Bar		VWTB24
C Vanity Mirror		VM**35

MEDICINE/LIGHTING CABINETS

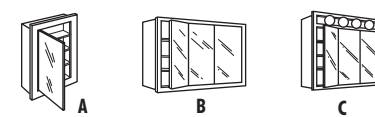

A Single Door Medicine Cabinet	MC16
B Tri-View Medicine Cabinet	TV**
C Tri-View Medicine Cabinet Lighted w/Chrome Face Plate	TMLC**32

PLAIN FILLERS

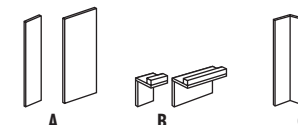

A Filler	F***	TF***	TF***FH
B Filler Return			F*R
C Corner Filler			CF3**

OVERLAY FILLERS

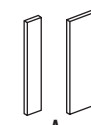

A Overlay Filler	OL***	VOL***	DOL***
-------------------------	-------	--------	--------

ORNATE FILLERS

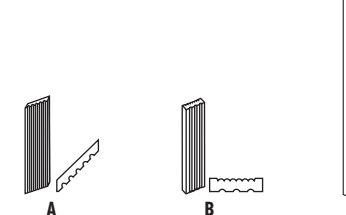

A Angled Fluted/Plain Reversible 3" Filler	BLVDFF**	BLVDTF96
B Fluted/Beaded Reversible 3" or 6" Filler	FBF***	TFBF*96
C Space Filler		S96X1*

BOX COLUMN FILLERS

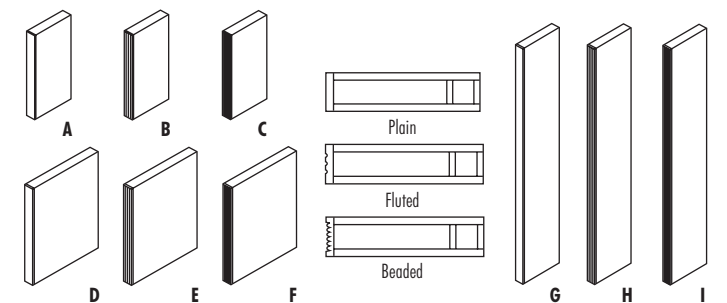

A Wall Plain	W***BCFP	
B Wall Fluted	W***BCFF	
C Wall Beaded	W***BCFB	
D Base Plain	B*34.527BCFP	
E Base Fluted	B*34.527BCFF	
F Base Beaded	B*34.527BCFB	
G Tall Plain	T***15BCFP	T***27BCFP
H Tall Fluted	T***15BCFF	T***27BCFF
I Tall Beaded	T***15BCFB	T***27BCFB

DECORATIVE APPLIANCE PANELS

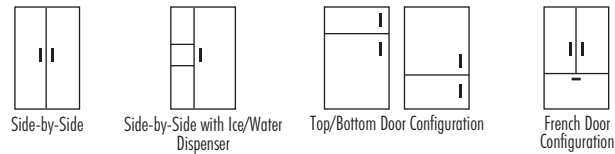

NOTE: Please see designer for complete listing of availability and sizes for customizable decorative appliance panels.

A Custom Panels	DAPNL1/4	DAPNL3/4
B Custom Doors	DADOORB	DADOORW
C Custom Doors w/Hinge Routing	DOORB*	DOORW*

PANELS & SKINS

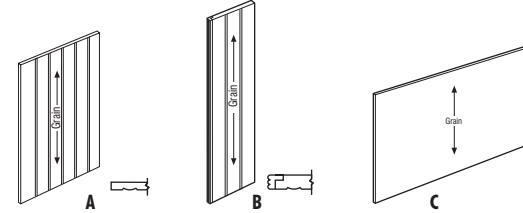

A Wood V-Grooved Panel Skin	BP4830VG	BP4834.5VG	BP4896VG
B Wood V-Grooved End Panel w/Triple Beaded Front	BEPPVG	TEP**VG	WEPP42VG
C Cross Grain Veneer Back Panel Skin	BP9634.5CRSGR		BP9648CRSGR

PANELS W/FILLER ATTACHED

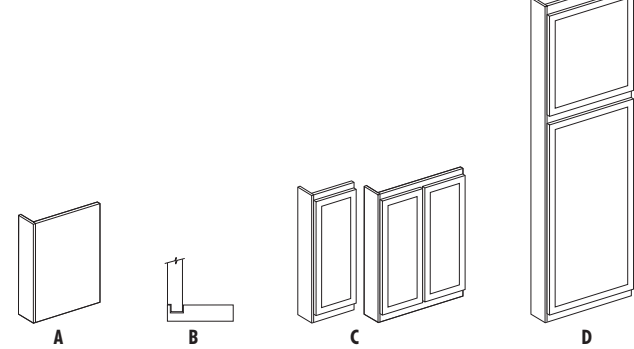

A Panels w/Filler Attached	WEP12**F1.5LAM	BEPF1.5LAM	TEP24**F1.5LAM
	WEP12**F1.5WD	BEPF1.5WD	TEP24**F1.5WD
	WEP12**F3LAM	BEPF3LAM	TEP24**F3LAM
	WEP12**F3WD	BEPF3WD	TEP24**F3WD
B Panels w/Filler Attached & Furniture Ends	WEP12**F1.5FPE	BEPF1.5FPE	TEP24**F1.5FPE
	WEP12**F3FPE	BEPF3FPE	TEP24**F3FPE
C Panels w/Filler Attached & Authentic Ends	WEP12**F1.5AEL	BEPF1.5AEL	TEP24**F1.5AEL
	WEP12**F1.5AER	BEPF1.5AER	TEP24**F1.5AER
	WEP12**F3AEL	BEPF3AEL	TEP24**F3AEL
	WEP12**F3AER	BEPF3AER	TEP24**F3AER
D Panels w/Filler Attached & Authentic Ends, Single Door	BEPF1.5AELSD	TEP**F1.5AELSD	
	BEPF1.5AERSD	TEP**F1.5AERSD	
	BEPF3AELSD	TEP**F3AELSD	
	BEPF3AERSD	TEP**F3AERSD	

CROWN MOULDINGS

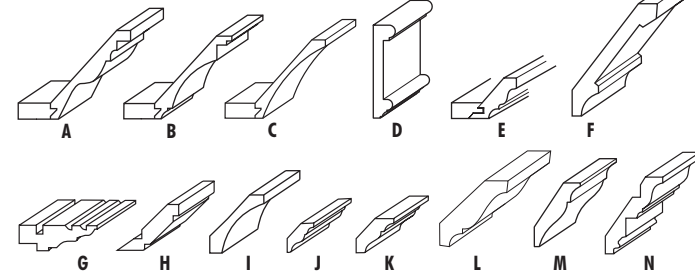

A Classic Tall Crown	CLTCROWN
B Cornice Tall Crown	COTCROWN
C Cove Crown	COVOCROWN
D Frieze Insert	JINSERTRM
E Full Overlay Crown	FOLCROWN
F Insert Crown	INSCROWN
G Plate Rail	PRB
H Shaker Crown	SHKRCRM8
I Small Cove Crown Moulding	SMCOVOCROWN
J Small Crown	SCM8
K Solid Wood Crown	SWCRM8
L Solid Wood Large Crown	SWLCRM8
M Solid Wood Tall Crown	SWTCRM8
N Solid Wood Victorian Crown	SWVCRM8

MOULDING INSERTS

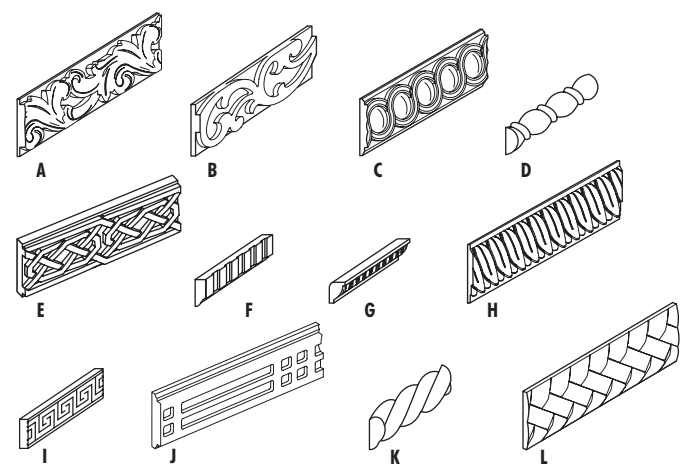

A Acanthus Insert	JACANINSERTM
B Baroque Insert	INSERTBARO
C Bijou Insert	JBUIINSERTM
D Braided	BRAIDM
E Celtic Insert	INSERTCELT
F Dentil	DEB
G Egg & Dart	EGDB
H Empress Insert	JEMPINSERTM
I Greek/Aztec	GREEKM
J Mission Insert	JMISINSERTM
K Rope	RPM8
L Weave Insert	JWEAVEINSERTM

ACCENT MOULDINGS

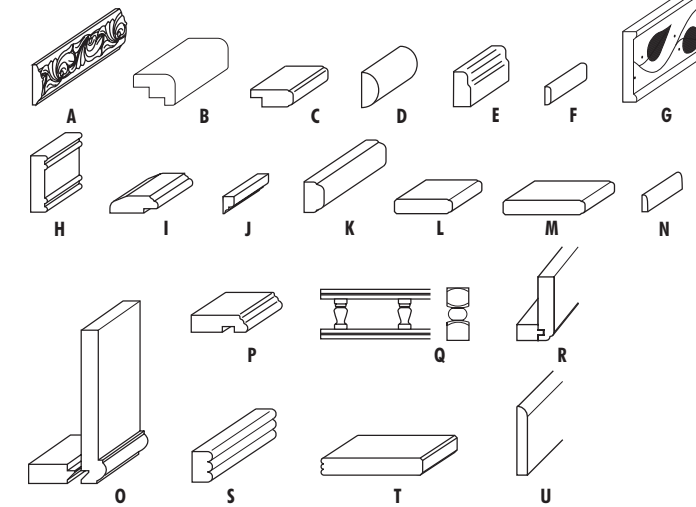

A Acanthus	ACAM
B Back Panel Moulding	BPM8
C Cabinet Panel Edge	CPE8
D Countertop Edge-Contemporary	CCM8
E Countertop Edge-Traditional	TCM8
F Flat Scribe	SM8
G Ivy	IVYM
H Library	LBRM
I Mirror Frame	VMF8
J Ogee Edge	OGEM
K Single Bead Edge	SBE8
L Single Bead Moulding	SBM8
M Single Bead Pilaster	SBPB
N Small Scribe	SSM
O Soffit Filler Moulding	SFM8
P Soffit Trim	TSTM
Q Spindle Rail/Corner Post	SRB/CORNERPOST
R Starter Moulding	STR8
S Triple Bead Edge	TBE8
T Triple Bead Pilaster	TBP8
U Wide Scribe	WSCRIBE

TOE MOULDINGS

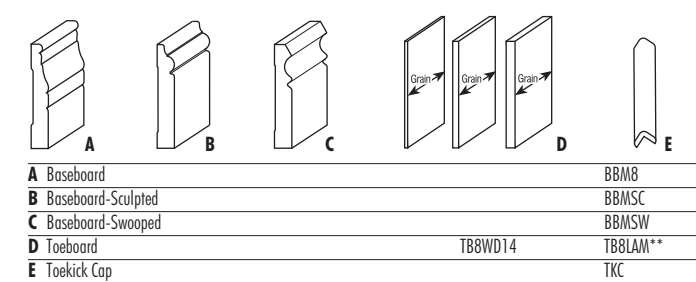

A Baseboard	BBM8
B Baseboard-Sculpted	BBMSC
C Baseboard-Swooped	BBMSW
D Toeboard	TB8WD14
E Toekick Cap	TB8LAM**
	TKC

WINDOW CASINGS



A Window Casing-Modern	WCA*
B Window Casing-Traditional	WCT*

LIGHT RAILS

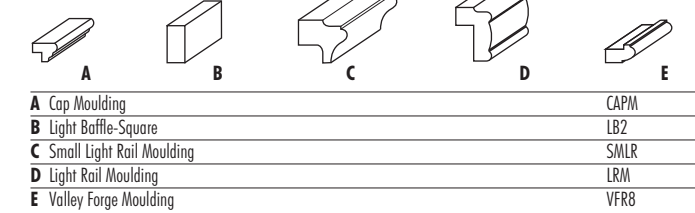

A Cap Moulding	CAPM
B Light Baffle-Square	LB2
C Small Light Rail Moulding	SMLR
D Light Rail Moulding	LRM
E Valley Forge Moulding	VFR8

CORNER MOULDINGS



A Diagonal Corner	DCM8
B Inside Corner	ICM8
C Large Outside Corner	LOSC8
D Outside Corner	OCM8
E Outside Corner 135°	OC135
F Quarter Round	QRM
G Shoe-Convex Inside Corner	SHM8

VALANCES

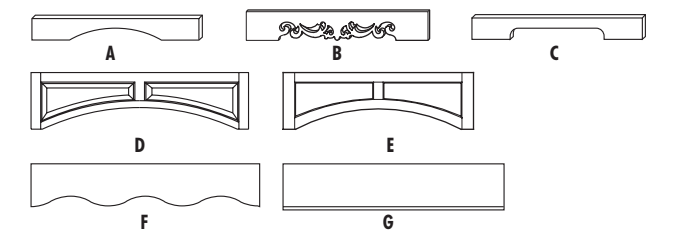

A Arched Valance	AV**
B Baroque Valance	JBV**
C Furniture Valance	FV**
D Raised Panel Arch Valance	RPV**
E Recessed Panel Arch Valance	JRCPV**
F Scalloped Valance	SV**
G Straight Valance	VV**

DECORATIVE OVERLAYS

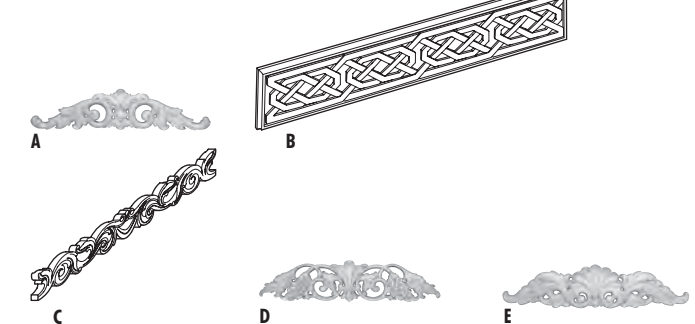

A Acanthus Overlay	ACOVLY
B Celtic Overlay	JCEOVLY
C Corinthian Overlay	JCOROVLY
D Grape Overlay	GROVLY
E Shell Overlay	SHOVLY

DECORATIVE ORNAMENTS

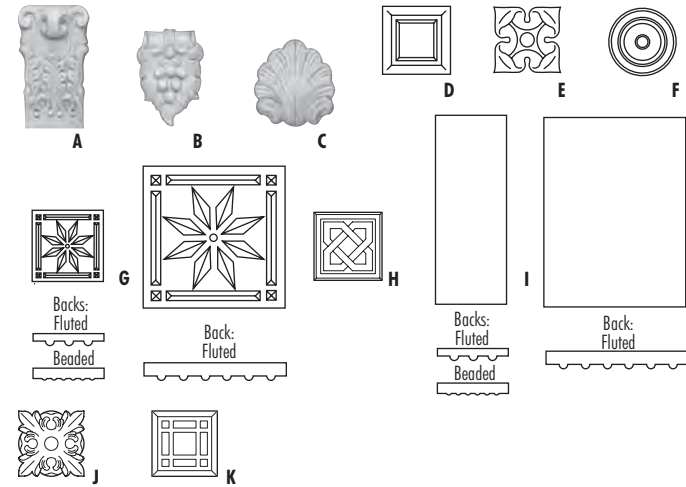

A Acanthus Ornament	ACO
B Grape Ornament	GRO
C Shell Ornament	SHELL
D Mission Rosette	ROSETTEMIS
E Scroll Rosette	ROSETTESCR
F Traditional Rosette	TROSETTE
G Corner Rosette-Fluted	FFRC"X" Beaded
H Celtic Rosette	ROSETTCELT
I Plinth Block Filler-Fluted	FFP"X8 Beaded
J Acanthus Tile	JTILEACAN
K Mission Tile	JTILEMISSION

DECORATIVE SUPPORTS

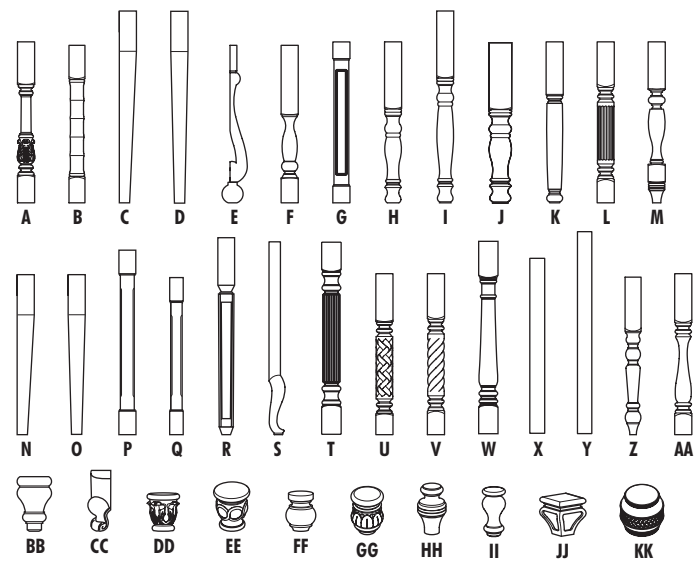

A Acanthus Leg	JACANTHUSLEG
B Bamboo Leg	JBAMBLEG
C Bar Leg, 2-Sided	2SBARLEG
D Bar Leg, 4-Sided	4SBARLEG
E Baroque Leg	JBAROQUELEG
F Buffet Leg	JBUFFETLEG
G Cosmo Leg	JCOSMOLEG
H English Country Leg	JENGCNTYLEG
I English Bar Column	ENGBARCOLUMN
J English Island Column	ENGISLCOLUMN
K Estate Leg	JESTATELEG
L Classic Fluted Leg	JFLUTELEG JFLUTELEGL JFLUTELEGT
M French Country Leg	JFRNCNTYLEG JFRNCNTYLEGL
N Island Leg, 2-Sided	2SISLLEG
O Island Leg, 4-Sided	4SISLLEG
P Metro Bar Column	METBARCOLUMN
Q Metro Island Column	METISLCOLUMN
R Mission Leg	DLEGMISSION
S Queen Anne Leg	JQUANNELEG
T Reed Leg	JRDLEGL JRDLEGT RDLEG
U Roman Weave Leg	JWEAVELEG JWEAVELEGL JWEAVELEGT
V Classic Rope Leg	JROPELEG JROPELEGL JROPELEGT
W Spool Leg	JSPLEGT SPLEG
X Square Island Leg	JSQISLLEG3 JSQISLLEG4 JSQISLLEG6
Y Square Bar Leg	JSQBARLEG3 JSQBARLEG4 JSQBARLEG6
Z Tulip Leg	JTULIPLEGL JTULIPLEGT
AA Urn Leg	JURNLEG JURNLEGL JURNLEGT
BB Abbe Foot	ABFOOT
CC French Leg	FRNLG
DD Acanthus Foot	JACANFOOT
EE Bijou Foot	JBIJFOOT
FF Craftsman Foot	JCRAFTFOOT
GG Empress Foot	JEMPFoot
HH French Country Foot	JFRNCNTYFOOT
II Madison Foot	JMADFOOT
JJ Metropolitan Foot	JMETROFOOT
KK Weave Foot	JWEAVEFOOT
LL Large Square Foot	LGSQFOOT
MM Lille Foot	LIFOOT
NN Plinth Block	PLBLOCK
OO Tapered Leg	TAPLG
PP Toekick Tulip Foot	TKTLFOOT
QQ Tulip Foot	TLFOOT

DECORATIVE SPLIT TURNINGS

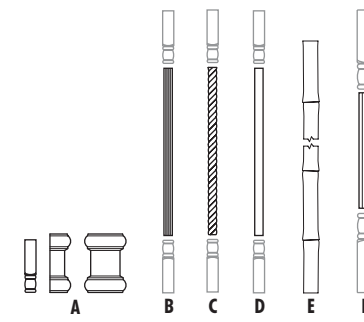

A End Split Turning	J3SPRINGBLK J3SPRINGCTR J3SPRINGFIN	J3SPRINGGW J3SPRINGCTR SPRINGEND
B Reed Split Turning	J3SPRINGRD96	"SPRINGREED**
C Rope Split Turning	J3SPRINGRP96	SPRINGROPE**
D Spool Split Turning	J3SPRINGSP96	SPRINGSPPOOL**
E Bamboo Split Turning	J3SPRINGBM48	J3SPRINGBAM48
F Fluted Split Turning	J3SPRINGFL96	J3SPRINGFLT96

DECORATIVE CORBELS & SHELF SUPPORTS

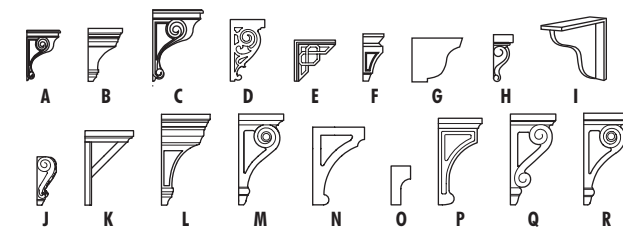

A 9" Small Corbel	SMCORBEL
B 9" Art Corbel	CORBELART9
C 13" Large Corbel	LCORBEL
D 10" Baroque Corbel	CORBELBARO
E 7" Celtic Corbel	CORBELCELT
F Mission Corbel	CORBELMIS*
G 5" Olde World Corbel	CORBELOWD5
H Scroll Corbel	CORBELSCR*
I Snack Bar Support	SBS
J Acanthus Corbel	JCORBELACAN**
K 1 1/2" Arts & Crafts Bracket	JBRACKETART
L 1 1/2" Arts & Crafts Open Corbel	JCORBELARTO
M 1 1/2" Bijou Corbel	JCORBELBIJ
N 1 1/2" Craftsman Open Bracket	JCORBELCRAFTO
O 3" Mini Shaker Corbel	JCORBELSHKR3
P Shaker Corbel	JCORBELSHKR**
Q 1 1/2" Traditional Open Corbel	JCORBELTRADO
R Weave Corbel	JCORBELWEAVE**

LIDS, POTS, PANS, & PLATES STORAGE

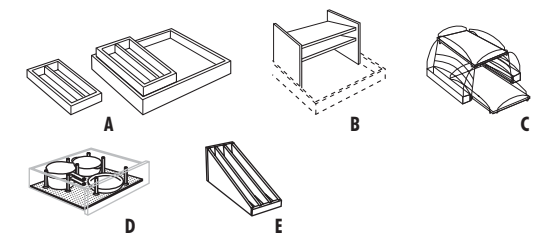

A Lid Organizer	LO24DPSS**	LO
B Base Pan Storage		BPS**
C Pots & Pans Pull-Out	PPP	PPP30
D Pegged Dish Organizer	PDO	PDOPOSTS
E Tray Divider Roll-Out Kit		TDRO**

TRAYS, BINS, RACKS, LIDS, BINS, & BROOM CLIP

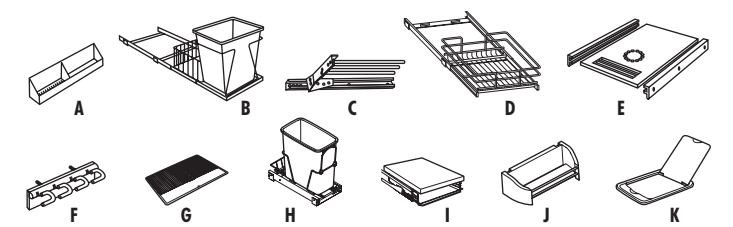

A Tilt Out Tray		TOT**
B Waste Bin w/White Plastic Trash Basket	SW15	
C Sliding Towel Rack		STR
D Vanity Chrome Roll-Out Rack		VCRR**21
E Bread Box Lid		BBX**
F Broom Clip		BRMCLP
G CabMat		CABMAT36
H Vanity Wastebasket Kit		VWB
I Base Mixer Kit		MIXKIT**FH
J Utility Easy Access Baskets		UEASBSK**
K Base Wastebasket Lid	BWBLID	BWBFLID

RACKS, DIVIDERS, ROLL-OUTS, & WALL SUSAN KITS



A Cookbook Rack		CBR
B Tray Divider Kit		CTDK
C Spice Rack		SR**
D Tray Divider Roll-Out Kit		TDRO**
E Wall Susan Kits		WSK**

SLIDING SHELF KITS & SHELVES

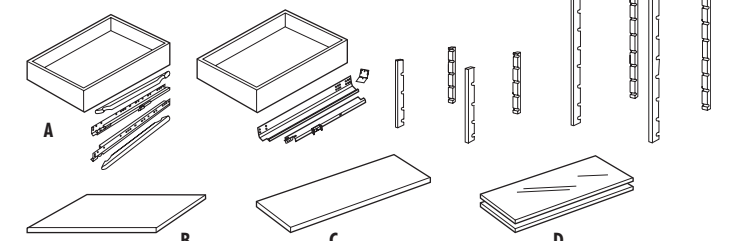

A	SS**	SS**ET	SS**SP	ETUPRIGHT	ETUPRIGHTOV
B Exterior Shelves					ES****
C Full Depth Shelves				SK9**	SK****
D Glass Shelf Kit					JSK****

LOOKING FOR MORE SCHROCK OPTIONS...VISIT SCHROCK.COM



Looking for more cabinetry options, finishes and features that capture your home's quest for personality? Or maybe a planning guide? Browse www.schrock.com for more ideas and inspiration. Whether your style is light and airy or deep and dramatic, our expressive offering of cabinetry has all the options you require to infuse warmth, texture and individuality within your home. Schrock Cabinetry. Beautiful on the outside. Smart on the inside.

EXPERT CRAFTSMANSHIP



SMART SOLUTIONS



SIGNATURE DETAILING



Schrock™ Cabinetry® is a certified brand in the Kitchen Cabinet Manufacturers Association (KCMA) Environmental Stewardship Program. The program recognizes companies that demonstrate an ongoing commitment to environmental practices and sustainability.

SCHROCK™ CABINERY
www.schrock.com

Front Cover Image: Galena Maple Coconut with Grey Stone Glaze

MasterBrand Cabinets © 2012, 1100129930 Printed in U.S.A. 2012-05/MOS/20.85M

Product photography and illustrations have been reproduced as accurately as printing technologies permit. To ensure highest satisfaction, we strongly recommend you view an actual sample for best color, wood grain and finish representation.

